



## AV Control Center



## MX136 Owner's Manual

Manufactured under license from Dolby Laboratories. "Dolby", "Pro Logic" and the double-D symbol are trademarks of Dolby Laboratories.

Manufactured under license under U.S. Patent No's: 5,451,942; 5,956,674; 5,974,380; 5,978,762; 6,226,616; 6,487,535 & other U.S. and worldwide patents issued & pending. DTS, DTS Digital Surround and Neo:6 are registered trademarks and the DTS logos and Symbol, and DTS 96/24 are trademarks of DTS, Inc. © 1996-2007 DTS, Inc. All Rights Reserved.

The lightning flash with arrowhead, within an equilateral triangle, is intended to alert the user to the presence of uninsulated “dangerous voltage” within the product’s enclosure that may be of sufficient magnitude to constitute a risk of electric shock to persons.



**AVIS** RISQUE DE CHOC ELECTRIQUE - NE PAS OUVRIR.

The exclamation point within an equilateral triangle is intended to alert the user to the presence of important operating and maintenance (servicing) instructions in the literature accompanying the appliance.

**WARNING - TO REDUCE RISK OF FIRE OR ELECTRICAL SHOCK, DO NOT EXPOSE THIS EQUIPMENT TO RAIN OR MOISTURE.**

**NO USER-SERVICEABLE PARTS INSIDE. REFER SERVICING TO QUALIFIED PERSONNEL.**

To prevent the risk of electric shock, do not remove cover or back. No user-serviceable parts inside.

## IMPORTANT SAFETY INSTRUCTIONS!

**PLEASE READ THEM BEFORE OPERATING THIS EQUIPMENT.**

1. Read these instructions.
2. Keep these instructions.
3. Heed all warnings.
4. Follow all instructions.
5. Do not use this apparatus near water.
6. Clean only with a dry cloth.
7. Do not block any ventilation openings. Install in accordance with the manufacturer’s instructions.
8. Do not install near any heat sources such as radiators, heat registers, stoves, or other apparatus (including amplifiers) that produce heat.
9. Do not defeat the safety purpose of the polarized or grounding-type plug. A polarized plug has two blades with one wider than the other. A grounding type plug has two blades and a third grounding prong. The wide blade or the third prong are provided for your safety. If the provided plug does not fit into your outlet, consult an electrician for replacement of the obsolete outlet.
10. Protect the power cord from being walked on or pinched particularly at plugs, convenience receptacles, and the point where they exit from the apparatus.
11. Only use attachments/accessories specified by the manufacturer.
12. Use only with the cart, stand, tripod, bracket, or table specified by the manufacturer, or sold with the apparatus. When a cart is used, use caution when moving the cart/apparatus combination to avoid injury from tip-over. 
13. Unplug this apparatus during lightning storms or when unused for long periods of time.
14. Refer all servicing to qualified service personnel. Servicing is required when the apparatus has been damaged in any way, such as power-supply cord or plug is damaged, liquid has been spilled or objects have fallen into the apparatus, the apparatus has been exposed to rain or moisture, does not operate normally, or has been dropped.
15. Do not expose this equipment to dripping or splashing and ensure that no objects filled with liquids, such as vases, are placed on the equipment.
16. To completely disconnect this equipment from the a.c. mains, disconnect the power supply cord plug from the a.c. receptacle.
17. The mains plug of the power supply cord shall remain readily operable.
18. Do not expose batteries to excessive heat such as sunshine, fire or the like.

## Outdoor Antenna Grounding

If an outside antenna or cable system is connected to the product, be sure the antenna or cable system is grounded so as to provide some protection against voltage surges and built-up static charge. Article 810 of the National Electrical Code, ANSI/NFPA 70, provides information with regards to proper grounding of the mast and supporting structure, grounding of the lead-in wire to an antenna discharge unit, and size of ground conductors, location of antenna-discharge unit, connection to ground electrodes and requirements for the grounding electrode.

Example of antenna grounding as per National Electrical Code, ANSI/NFPA 70

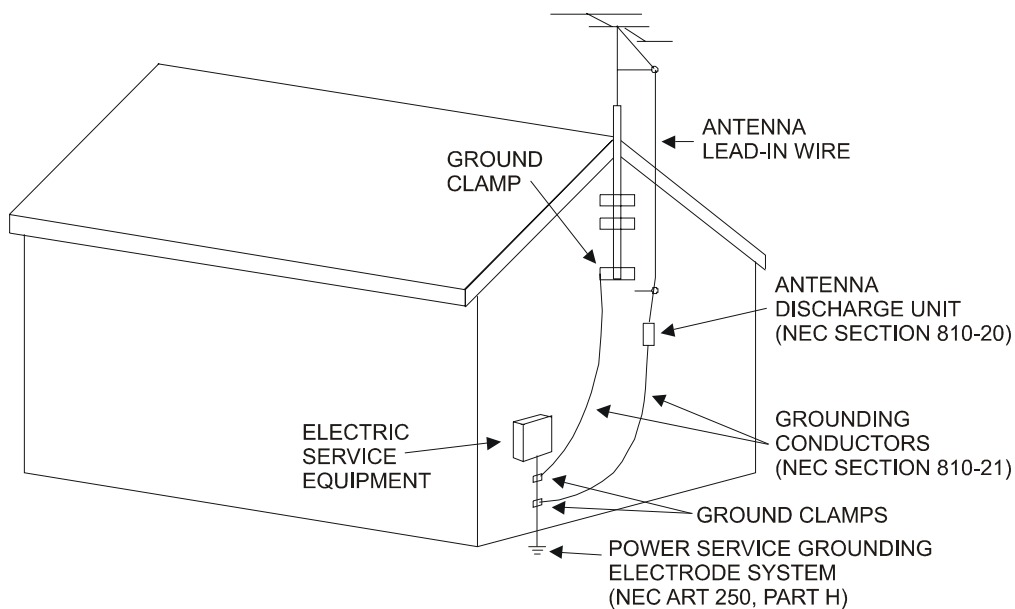



## Thank You

Your decision to own this McIntosh MX136 A/V Control Center ranks you at the very top among discriminating music listeners. You now have “The Best.” The McIntosh dedication to “Quality,” is assurance that you will receive many years of musical enjoyment from this unit.

Please take a short time to read the information in this manual. We want you to be as familiar as possible with all the features and functions of your new McIntosh.

## Please Take A Moment

The serial number, purchase date and McIntosh Dealer name are important to you for possible insurance claim or future service. The spaces below have been provided for you to record that information:

**Serial Number:** \_\_\_\_\_

**Purchase Date:** \_\_\_\_\_

**Dealer Name:** \_\_\_\_\_

## Technical Assistance

If at any time you have questions about your McIntosh product, contact your McIntosh Dealer who is familiar with your McIntosh equipment and any other brands that may be part of your system. If you or your Dealer wish additional help concerning a suspected problem, you can receive technical assistance for all McIntosh products at:

McIntosh Laboratory, Inc.  
2 Chambers Street  
Binghamton, New York 13903  
Phone: 607-723-1545  
Fax: 607-723-3636

## Customer Service

If it is determined that your McIntosh product is in need of repair, you can return it to your Dealer. You can also return it to the McIntosh Laboratory Service Department. For assistance on factory repair return procedure, contact the McIntosh Service Department at:

McIntosh Laboratory, Inc.  
2 Chambers Street  
Binghamton, New York 13903  
Phone: 607-723-3515  
Fax: 607-723-1917

## Table of Contents

Safety Instructions .....	2
Thank You and Please Take a Moment .....	4
Technical Assistance and Customer Service .....	4
Table of Contents .....	4
Important Information .....	5
Connector Information .....	6
Introduction .....	7
Performance Features .....	7
Dimensions .....	8
Installation .....	9
<b>Connections</b>	
Rear Panel Multizone, Control and Switch .....	10
Rear Panel Analog and Digital Audio Connections .....	11
Rear Panel Video Connections .....	12
How to Connect Data and Power Control .....	13
How to Connect Digital Audio Components .....	14
How to Connect Analog Audio Components for five or six channels .....	15
How to Connect Analog Audio Components for eight channels .....	16
How to Connect Video Components .....	18
How to Connect for Zone B .....	19
<b>Front Panel Features</b>	
Front Panel Controls and Sensor .....	20
Front Panel Push-button and Switch .....	21
Front Panel Displays .....	22
<b>Remote Control</b>	
Remote Control Push-Buttons .....	24
How to Operate by Remote Control .....	25
<b>Setup Mode</b>	
How to Operate the Setup Mode .....	26
Default Settings .....	27
How to Adjust for Loudspeaker Size .....	28
How to Adjust Loudspeaker Time Delay .....	30
How to Adjust Loudspeaker Levels .....	31
How to Change the Input Setup .....	33
How to Change the Volume Setup .....	38
How to Change the Advanced Settings .....	39
<b>Operation</b>	
How to Operate the MX136 .....	41
How to Operate the Trim Mode .....	44
How to Operate the Surround Mode .....	47
How to Make a Recording .....	49
How to Operate Zone B .....	50
<b>Additional Information</b>	
Audio and General Specifications .....	51
<b>TM1 AM/FM Tuner Module</b>	
TM1 Table of Contents .....	52
Packing Instructions .....	59

## Important Information

1. The MX136 A/V Control Center has provisions for adding an optional McIntosh TMI AM/FM Tuner Module for Radio Station Reception. The TMI is available from your McIntosh Dealer and can be installed at any time, usually while you wait. Refer to page 52 for additional TMI information.
2. Before making any connections to the MX136, make sure the Main POWER Switch is in the Off position. Failure to do so could result in malfunctioning of some or all of the system's normal operations.
3. Zone A accepts, unbalanced Analog Signals, Balanced Analog Audio Signals and Digital Audio Signals. Zone B and the Record Output Signal only accept unbalanced Analog Signals. When connecting source devices with audio outputs to the MX136, make sure to also connect the unbalanced outputs.
4. The connection of a turntable to the PH/AUX Input jacks requires changes to be made in the SETUP Mode, refer to page 32. If a recording is made from the turntable and/or listening to a record in Zone B of the MX136, both the INPUT A and INPUT B Controls need to be placed in the PH/AUX position.
5. Connecting Cables are available from the McIntosh Parts Department:
  - Data and Power Control Cable Part No. 170-202**  
Six foot, shielded 2 conductor, with 1/8 inch stereo mini phone plugs on each end.
  - Control Center to Multi-Channel Power Amplifier Cable Part No. 170-631**  
Six foot, DB25, shielded, straight through, 25 conductor male-to-female cable.
6. When the MX136 is connected to some McIntosh Multichannel Power Amplifiers with a 25 conductor cable, the amplifier meters may automatically indicate the output of individual channels during the Speaker Level Setup Operation. Refer to the Power Amplifiers Owner's Manual for additional information.
7. The MX136 Input Source Name "DVD" is equivalent to "V-Aux" on some McIntosh Keypads, Remote Controls and Audio/Video Control Centers.
8. Up to two McIntosh Sensors or Keypads can be wired in parallel for both Zones A and B.
9. When a McIntosh WK-2 Keypad or a R649 Sensor is to be connected to the McIntosh MX136 A/V Control Center that uses a RJ-45 Connector Plug instead of the "F" Coaxial Connector, connect the Center Conductor to Pin 1 and the Shield Conductor to Pin 2. Refer to the figure below.
10. The Zone A and Zone B IR Inputs, with 1/8 inch mini phone jacks, are configured for non-McIntosh IR sensors such as a Xantech Model 291-80. To avoid possible interaction, disable the MX136 Front Panel Sensor with the switch recessed in the bottom panel behind and to the left of the Sensor.
11. System Setup operations must be performed in the order they appear in the Main System Setup Menu as they are interactive.
12. In order to hear bass frequencies below 80Hz, your system must include either a Subwoofer or Large Front Loudspeakers.
13. When an assigned Digital Input and a matching Analog Input are in use, the MX136 automatically searches first for a Digital Signal. If no Digital Signal is sensed, it switches to the Analog Input.
14. Some disk players have the ability to provide only a single output (Digital or Analog) when a DTS Sound Track is playing. If the Digital Output is selected in the player setup mode, the players Analog Audio Output Signal will have the undecoded DTS Sound Signal which will be heard as noise.
15. There are three types of Video Signals that can be connected to and selected by the MX136; Composite, S-Video and Component. Zone A and B, VCR 1 and 2 have both Composite and S-Video Outputs; the Component Video Output is for Zone A only. The MX136 has Digital Video Processing Circuitry that will Up-Convert the desired Composite Input to S-Video; it will also Up-Convert the desired Composite and/or S-Video Inputs to Component Video.
16. The MX136 has built-in HDMI Digital Video Selection for Zone A and has Digital Video Processing Circuitry to convert and upscale any Composite Video, S-Video, and Component Video Signals to Digital Video (480p, 720p or 1080i).
17. To view Component Video, S-Video and Composite Video Input Sources through the HDMI Video Monitor A Output, it is necessary to first go into the Setup Mode, select the Input Setup Menu (HMDI Video/Component Video Menu items) and make the appropriate changes from the default settings. For additional information refer to pages 35, 36 and 37.
18. For additional connection information, refer to the owner's manual(s) for any component(s) connected to the MX136 A/V Control Center.

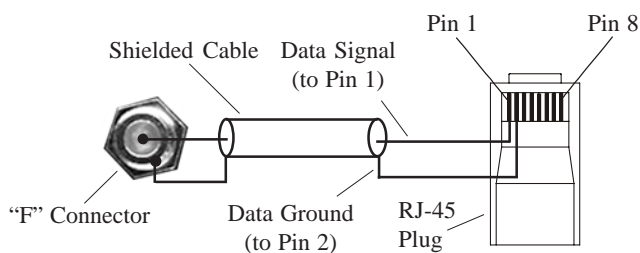

## Connector Information

### Keypad Terminal Connector

To use a WK-3 or WK-4 Keypad with the MX136, connect the shield and four leads of a shielded 4 conductor cable to a RJ-45 Connector Plug, according to the numbers listed below. There is a numbered connector built into each Keypad, which has a different pin out.

#### MX136 RJ-45

1. Signal Data
2. Signal Data Gnd. and Cable Shield
3. N/C
4. Supply Voltage Negative
5. Supply Voltage Positive
6. N/C
7. N/C
8. N/C

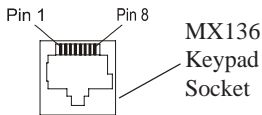

#### WK-3 and WK-4 Keypad

1. Supply Voltage Positive
2. Supply Voltage Negative
3. Cable Shield
4. Signal Data
5. Signal Data Gnd.

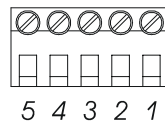

### RS232 DB9 Connector Pin Layout

1. N/C
2. Data Out (TXD)
3. Data In (RXD)
4. N/C
5. Gnd.
6. N/C
7. N/C
8. N/C
9. N/C

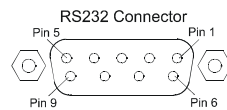

### Multi-Channel Amp DB25 Connector Pin Layout

1. Left Front +
2. Center Front +
3. Right Front +
4. Subwoofer +
5. Left Surround +
6. Right Surround +
7. Left Back Surround +
8. Right Back Surround +
9. N/C
10. N/C
11. N/C.
12. System Calibrate
13. Power Control In
14. Left Front Gnd.
15. Center Front Gnd.
16. Right Front Gnd.
17. Subwoofer Gnd.
18. Left Surround Gnd.
19. Right Surround Gnd.
20. Left Back Surround Gnd.
21. Right Back Surround Gnd.
22. N/C
23. N/C
24. System Calibrate Gnd.
25. Power Control Gnd.

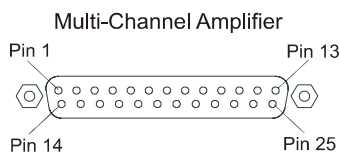

### XLR Connectors

Below is the Pin configuration for the XLR Balanced Input and Output Connectors on the MX136. Refer to the diagram for connection:

- PIN 1: Shield/Ground
- PIN 2: + Signal
- PIN 3: - Signal

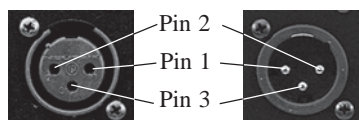

### Power Control Connector

The MX136's Power Control Outputs provide a 5 volt signal. Use a 1/8 inch stereo mini phone plug to connect to the Power Control Input on other McIntosh Components.

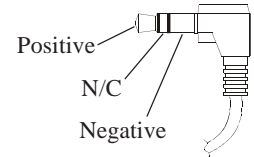

### Data and IR Input Port Connectors

The MX136's Data Port Output provides Remote Control Signals. Use a 1/8 inch stereo mini phone plug to connect to the Data Port Inputs on McIntosh Source Units. The IR Ports also use a 1/8 inch stereo mini phone plug and allows the connection of other brands IR Sensors to the MX136.

*Note: The MX136 Rear Panel IR POWER Switch setting determines if twelve volts are present at the Zone A and B IR INPUTS.*

#### IR Input Port Connector with Rear Panel IR Power Switch Set to Off

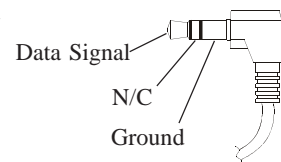

#### IR Input Port Connector with Rear Panel IR Power Switch Set to On

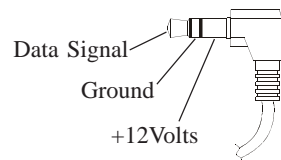

### Introduction

---

Now you can take advantage of traditional McIntosh standards of excellence in the MX136 A/V Control Center as the heart of your Home Theater System. The MX136 provides superior eight channel reproduction with the latest in digital decoding combined with complete audio and video switching. The McIntosh MX136 sets new standards for accuracy in a Home Theater System.

### Performance Features

---

- **Balanced Inputs and Outputs**

Two pairs of Balanced high level Inputs and an eight channel Balanced Output are provided.

- **Moving Magnet Phono Input**

There is a Precision Phono Preamplifier for Moving Magnet Cartridges.

- **On-Screen and Multifunction Fluorescent Displays**

A comprehensive On-Screen Display capability makes it easy to perform setup adjustments using the Remote Control. The front panel display indicates volume levels, tuner functions, input selection, operating mode and setup functions.

- **Automatic Mode Switching with Auto Memory**

The MX136 Automatically Switches Operating Modes according to the input signal. Zone A will memorize the Preferred Mode settings last used for each input.

- **Separate Listen and Record Input Selection**

The 12 Analog A/V Inputs can be retitled for any desired signal sources. Any unused input can be “turned off” so the input selector will skip over it. All six digital inputs can be assigned to any A/V signal source for Zone A. Separate Record and Listen Circuits allow recording of one program source while listening to another.

- **Latest in Digital Audio Processing**

The MX136 incorporates the latest technology in digital multi-channel processing, including Dolby Digital EX, Pro Logic IIx, DTS-ES and NEO:6.

- **LED Channel Status Indicators**

The MX136 includes twenty-four LEDs on the front panel to indicate what type of operating signals are being received, signal processing mode and the output format chosen.

- **Pure Stereo Outputs**

When the Stereo Mode of Operation is selected for an analog source the signal is amplified with no digital processing placed in the signal path.

- **Adjustable Channel Level and Time Delay**

A built-in test signal generator allows all eight channels to be calibrated for precise volume levels with either automatic or manual channel switching and can be adjusted for time delay to compensate for different distances from each Loudspeaker to the listening area.

- **Digitally Controlled Volume and Tone Controls**

A Precision Tracking Volume Control adjusts all eight channels with tracking accuracy better than 0.5dB. Digitally controlled bass, treble and loudness analog circuits provide a wide range of tone shaping with no loss in traditional McIntosh sonic excellence.

- **HDMI Video Switching with Digital Video Processing**

There are four HDMI Inputs and any Composite Video, S-Video, Component Video Input can be Up-Converted to a Component Video Signal and Digital Video Signal with the built-in Digital Video Processing Circuitry.

- **External Eight Channel Input**

An external eight channel signal processor can be connected to these inputs as well as a DVD-Audio Player or Super Audio Disc Player with a built-in processor.

- **Dual Zone**

The MX136 has the built-in ability to control a separate remote audio/video zone with program selection independent of Zone A, using a dedicated power amplifier and speakers.

- **Fiber Optic Solid State Front Panel Illumination**

The Illumination of the Front Panel is accomplished by the combination of custom designed Fiber Optic Light Diffusers and Light Emitting Diodes (LEDs). This provides uniform Front Panel Illumination, together with the extra long life of the LEDs.

- **Glass Front Panel**

The famous McIntosh Illuminated Glass Front Panel ensures the pristine beauty of the MX136 will be retained for many years.



### Dimensions

The following dimensions can assist in determining the best location for your MX136. There is additional information on the next page pertaining to installing the MX136 into cabinets.

Front View of the MX136

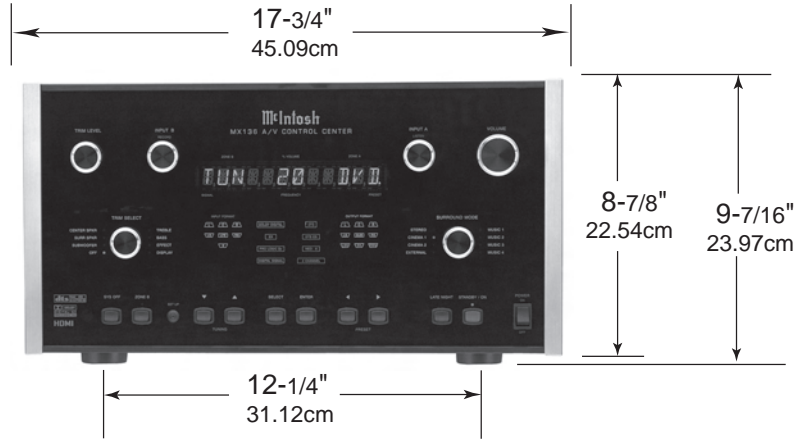

Rear View of the MX136

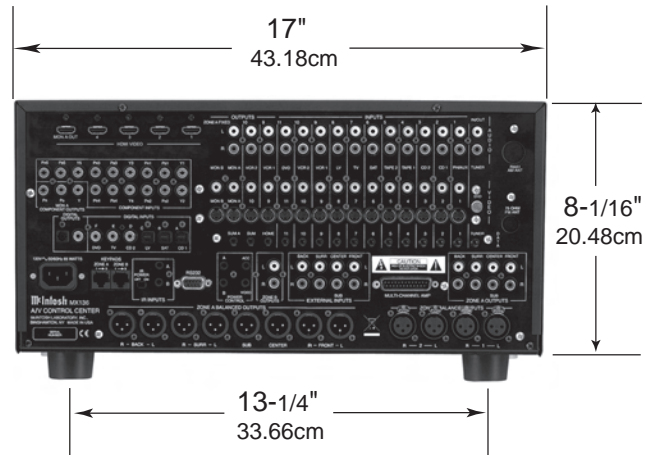

Side View of the MX136

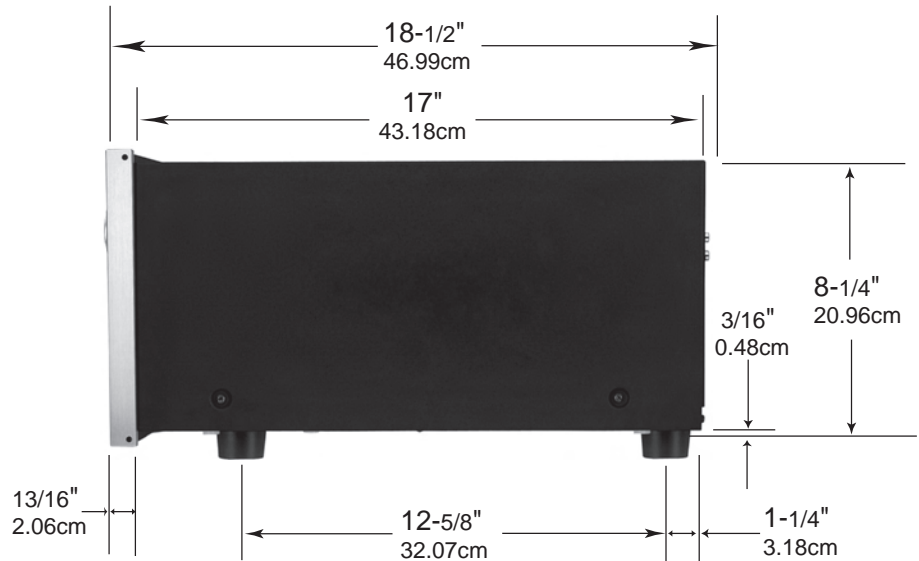



## Installation

The MX136 can be placed upright on a table or shelf, standing on its four feet. It also can be custom installed in a piece of furniture or cabinet of your choice. The four feet may be removed from the bottom of the MX136 when it is custom installed as outlined below. The four feet together with the mounting screws should be retained for possible future use if the MX136 is removed from the custom installation and used free standing. The required panel cutout, ventilation cutout and unit dimensions are shown.

Always provide adequate ventilation for your MX136. Cool operation ensures the longest possible operating life for any electronic instrument. Do not install the MX136 directly above a heat generating component such as a high powered amplifier. If all the components are installed in a single cabinet, a quiet running ventilation fan can be a definite asset in maintaining all the system components at the coolest possible operating temperature.

A custom cabinet installation should provide the following minimum spacing dimensions for cool operation. Allow at least 2 inches (5.08cm) above the top, 2 inches (5.08cm) below the bottom and 1 inch (2.54cm) on each side of the A/V

Control Center, so that airflow is not obstructed. Allow 21 inches (53.34cm) depth behind the front panel. Allow 1 inch (2.54cm) in front of the mounting panel for knob clearance. Be sure to cut out a ventilation hole in the mounting shelf according to the dimensions in the drawing.

**MX136 Front Panel Custom Cabinet Cutout**

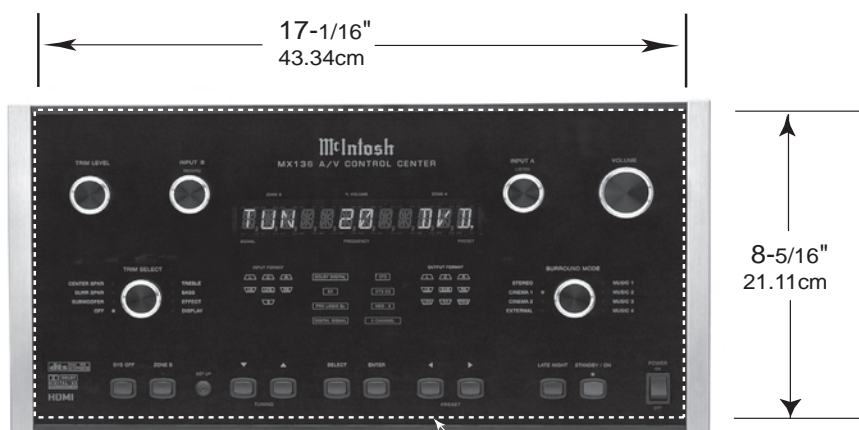

**MX136 Side View in Custom Cabinet**

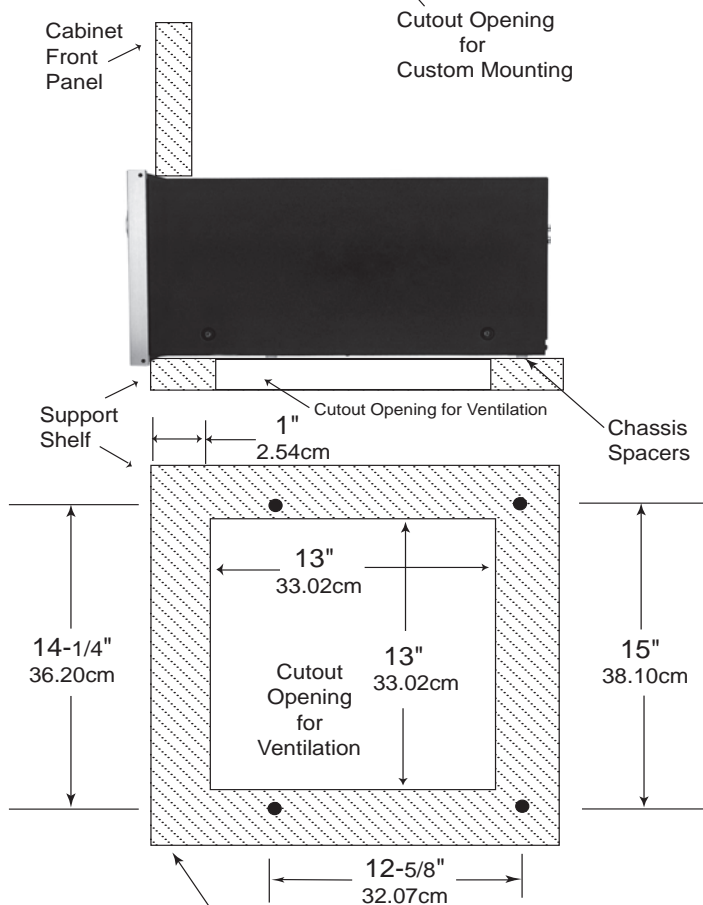

**MX136 Bottom View in Custom Cabinet**

Notes: Center the Cutout Horizontally on unit. For purposes of clarity, the above illustration is not drawn to scale.



# Rear Panel Multizone, Control Connections and Switch

IR POWER On/Off for Zone A or B external Sensors

RS232 connector for connection to a computer or other control device

SUM A Data Port for connections to other McIntosh Components

SUM Data Port for Zones A and B provides connections to the other McIntosh Components

HOME Data Port connects to the optional HC-1 Home Controller

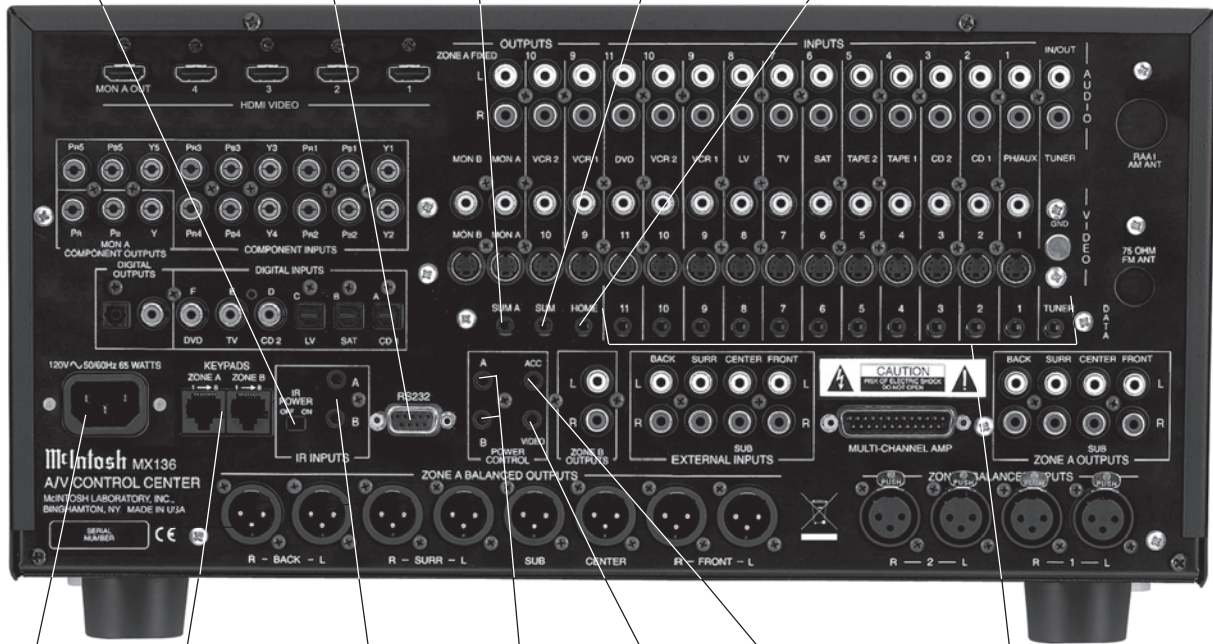

KEYPADS ZONE A and B for a McIntosh Keypad or IR room sensor

POWER CONTROL A and B send a turn On/Off signal to a McIntosh Power Amplifier for each Zone

ACC sends a turn On/Off signal to McIntosh Source Components

CONNECT THE MX136 power cord to a live AC outlet. Refer to information on the back panel to determine the correct voltage

IR INPUTS for Zone A or B external sensors

VIDEO sends a turn On/Off signal to McIntosh Video Source Components

DATA Ports send signals to compatible source components to allow remote control operation

## Rear Panel Analog Audio and Digital Audio Connections

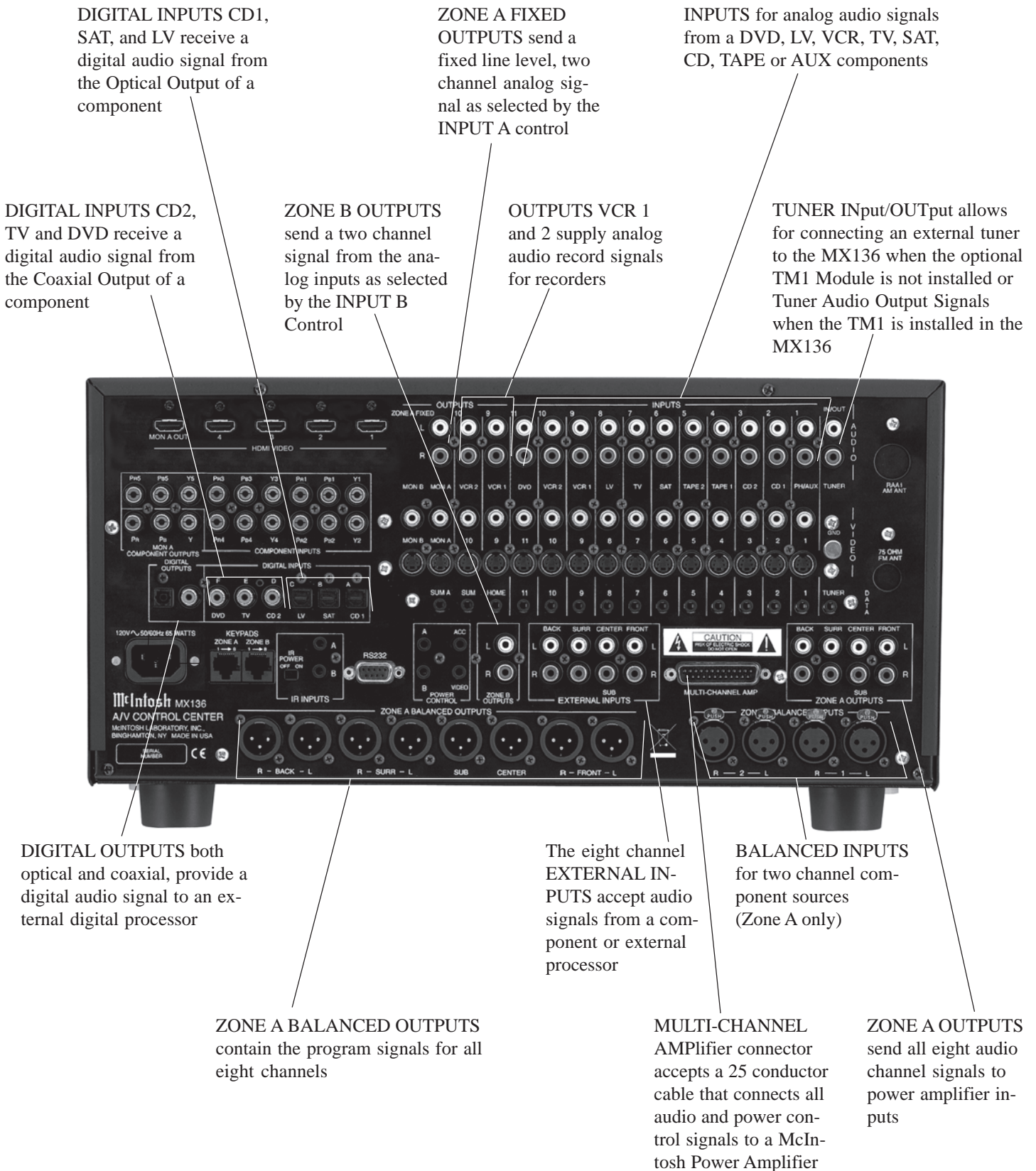



COMPONENT INPUTS receive Component Video (Y, P<sub>R</sub> and P<sub>B</sub>) Signals from five Component Video Sources

HDMI INPUTS for Digital Video Signals from four HDMI Video Sources

OUTPUTS for VCR 1 and 2 supply Composite Video Signals for recorders

*Note: If the MX136 A/V System Control Center has the TM1 AM/FM Tuner Module installed, proceed to page 53 for Rear Panel Antenna Connection Information.*

HDMI MONitor A OUTPUT for Digital Video Signal to a monitor/TV located in Zone A

OUTPUT MONitor A sends a Composite or S-Video Signal to a monitor/TV located in Zone A

INPUTS for Composite Video Signals from a DVD, LV, VCR, TV, SAT, CD, TAPE or AUX components

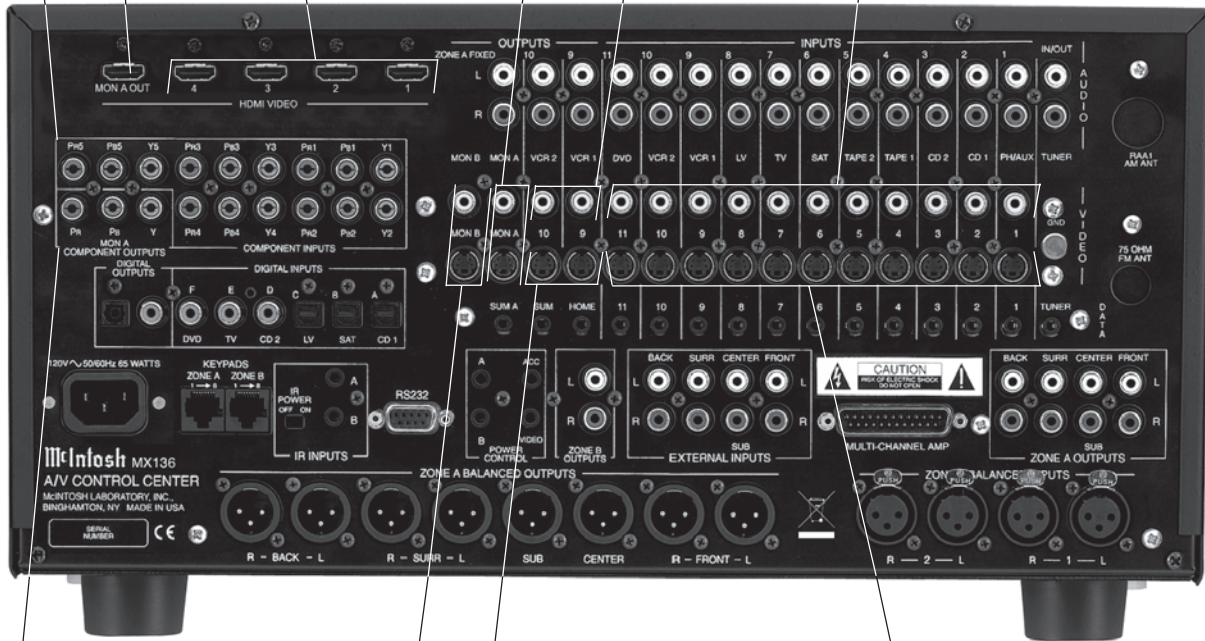

OUTPUT MONitor B sends a Composite or S-Video Signal to a monitor/TV located in Zone B

INPUTS for S-Video Signals from a DVD, LV, VCR, TV, SAT, CD, TAPE or AUX components

COMPONENT OUTPUTS send Component Video (Y, P<sub>R</sub> and P<sub>B</sub>) Signals to the ZONE A Video Monitor

OUTPUTS for VCR 1 and 2 supply S-Video Signals for recorders

## How to Connect Data and Power Control

1. Connect a Data Control Cable from the MX136 AUDIO VIDEO (input 11) Data Port to the McIntosh AUDIO VIDEO Player Data In Jack.

*Note: By adding a McIntosh Remote Control Translator to the MX136, non McIntosh Source Devices such as a Satellite Receiver can be remotely controlled using a McIntosh Remote Control and Keypads.*

2. Connect a Data Control Cable from the MX136 HOME Data Port to the Home Controller Data In Jack.
3. Connect a 4 conductor shielded cable from the MX136 ZONE A KEYPAD Socket to a McIntosh WK-4 Keypad.
4. Connect a Power Control Cable from the MX136 POWER CONTROL ACC Jack to the McIntosh AUDIO VIDEO Player Power Control In Jack.
5. Connect a Power Control Cable from the MX136 POWER CONTROL A Jack to the McIntosh Powered Subwoofer Power Control In Jack.

6. Connect a Power Control Cable from the McIntosh Powered Subwoofer Power Control Out Jack to the McIntosh Power Control AC Outlet Strip Power Control Jack.
7. Optionally, connect a Data Control Cable from the MX136 IR INPUTS A to an external IR Sensor.

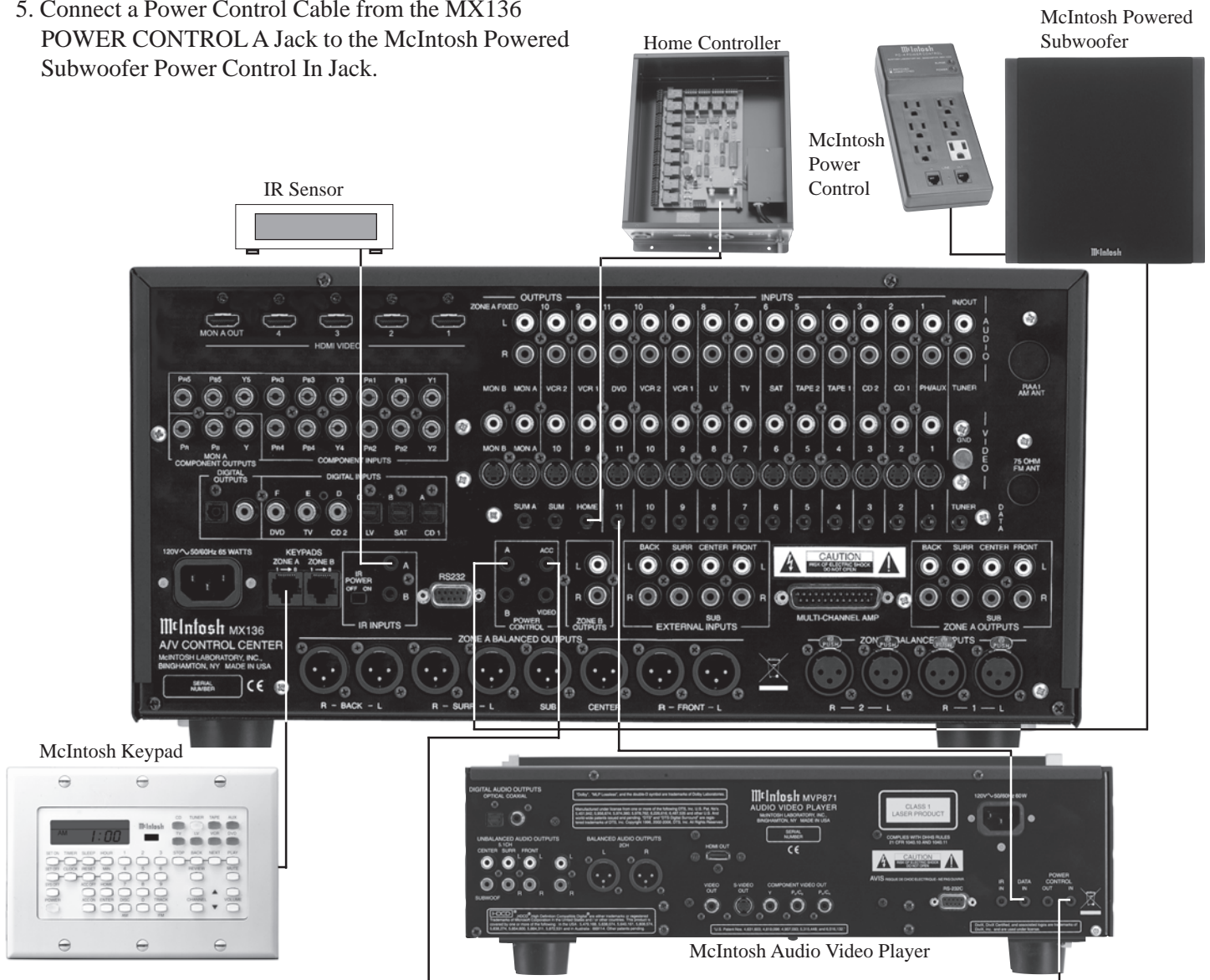



### How to Connect Digital Audio Components

1. Connect a cable from the MX136 DIGITAL COAXIAL AUDIO VIDEO INPUT (Input F) to the McIntosh Coaxial Digital Output of the McIntosh AUDIO VIDEO Player.
2. Connect a cable from the MX136 SAT INPUT (Input B) OPTICAL DIGITAL INPUT to the Optical Digital Output of a Satellite Receiver.
3. Connect a cable from the MX136 LV INPUT (Input C) OPTICAL DIGITAL INPUT to the Optical Digital Output of a Digital Audio Recorder.
4. Connect a cable from the Digital Audio Recorder Input to the MX136 OPTICAL DIGITAL OUTPUT.

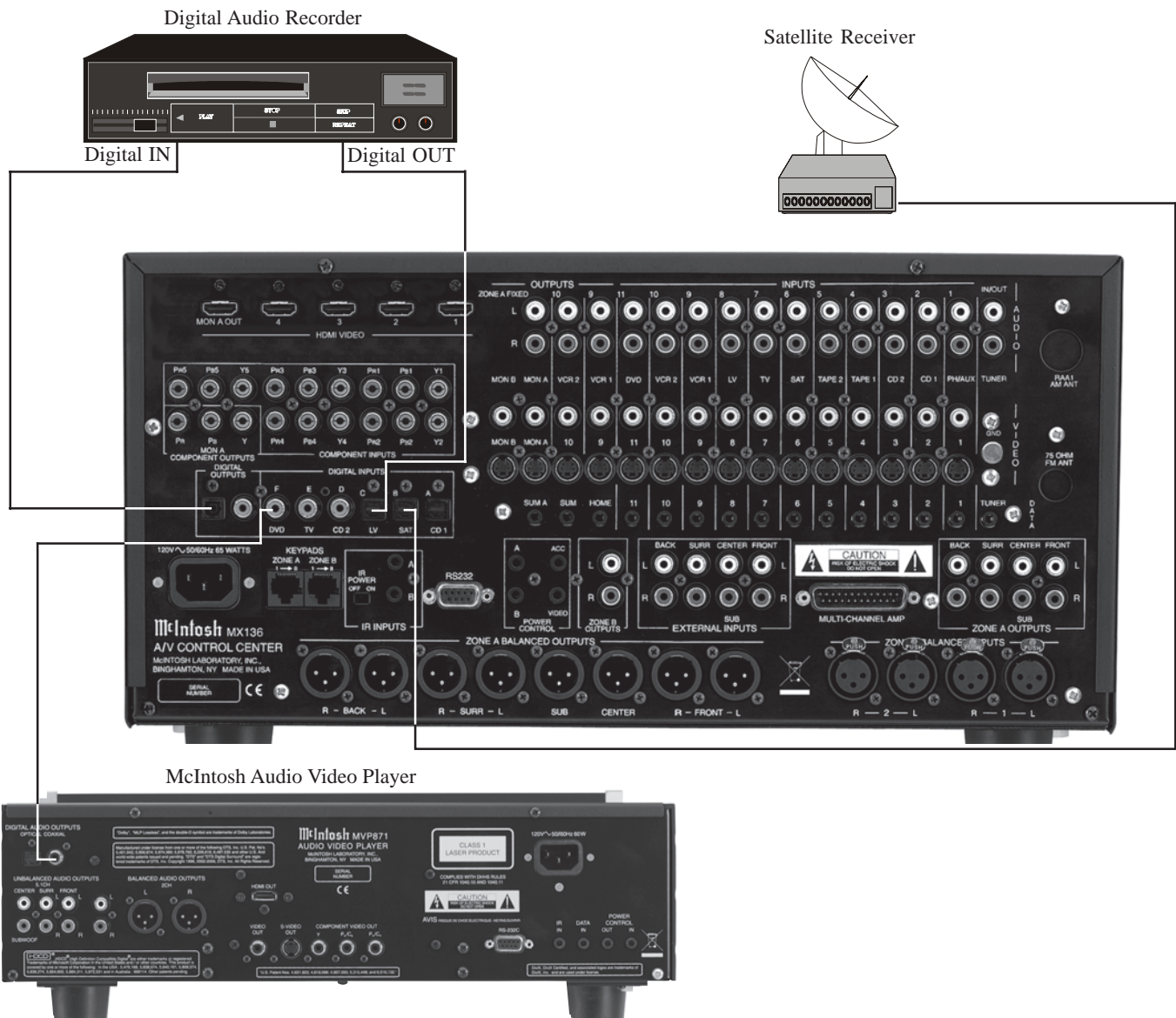

## How to Connect Analog Audio Components for five or six channels

The MX136 accepts Analog Audio and Digital Audio Signal Inputs. It is important to connect the Analog Outputs along with the Digital Audio Signal Output from source components connected to the MX136. This will assure the audio from the source component is available to the REC Outputs and Zone B Outputs.

1. Connect unbalanced cables from the MX136 ZONE A OUTPUTS FL (Front Left), CTR (Front Center), FR (Front Right), LS (Left Surround), RS (Right Surround) to the McIntosh Five Channel Power Amplifier making sure to match the channel identifications.
2. Connect a cable from the MX136 Analog Audio INPUTS (Input 11) to the McIntosh 2 CH Audio Outputs of the McIntosh AUDIO VIDEO Player.
3. Connect balanced cables from the MX136 ZONE A BALANCED INPUTS 1 to the McIntosh Balanced Audio Outputs of the McIntosh AUDIO VIDEO Player.
4. Connect cables from the MX136 EXTERNAL Audio

- INPUTS to the McIntosh 5.1CH Audio Outputs of the McIntosh AUDIO VIDEO Player.
5. Connect a cable from the MX136 Left and Right Analog Audio INPUTS (Input 6) to the Left and Right Analog Audio Outputs of the Satellite Receiver.
6. Connect a cable from the MX136 VCR1 Audio OUTPUT (Output 9) to the VCR Audio Input.
7. Connect a cable from the MX136 VCR1 Audio INPUT (Input 9) to the VCR Audio Output.
8. Connect a cable from the MX136 LV Audio INPUT (Input 8) to the Digital Audio Recorder Analog Output.
9. Connect a cable from the MX136 VCR2 Audio OUTPUT (Output 10) to Digital Audio Recorder Analog Input.
10. Connect a cable from the MX136 ZONE A SUBwoofer OUTPUTS to the McIntosh Powered Subwoofer Subwoofer Line In Jack.

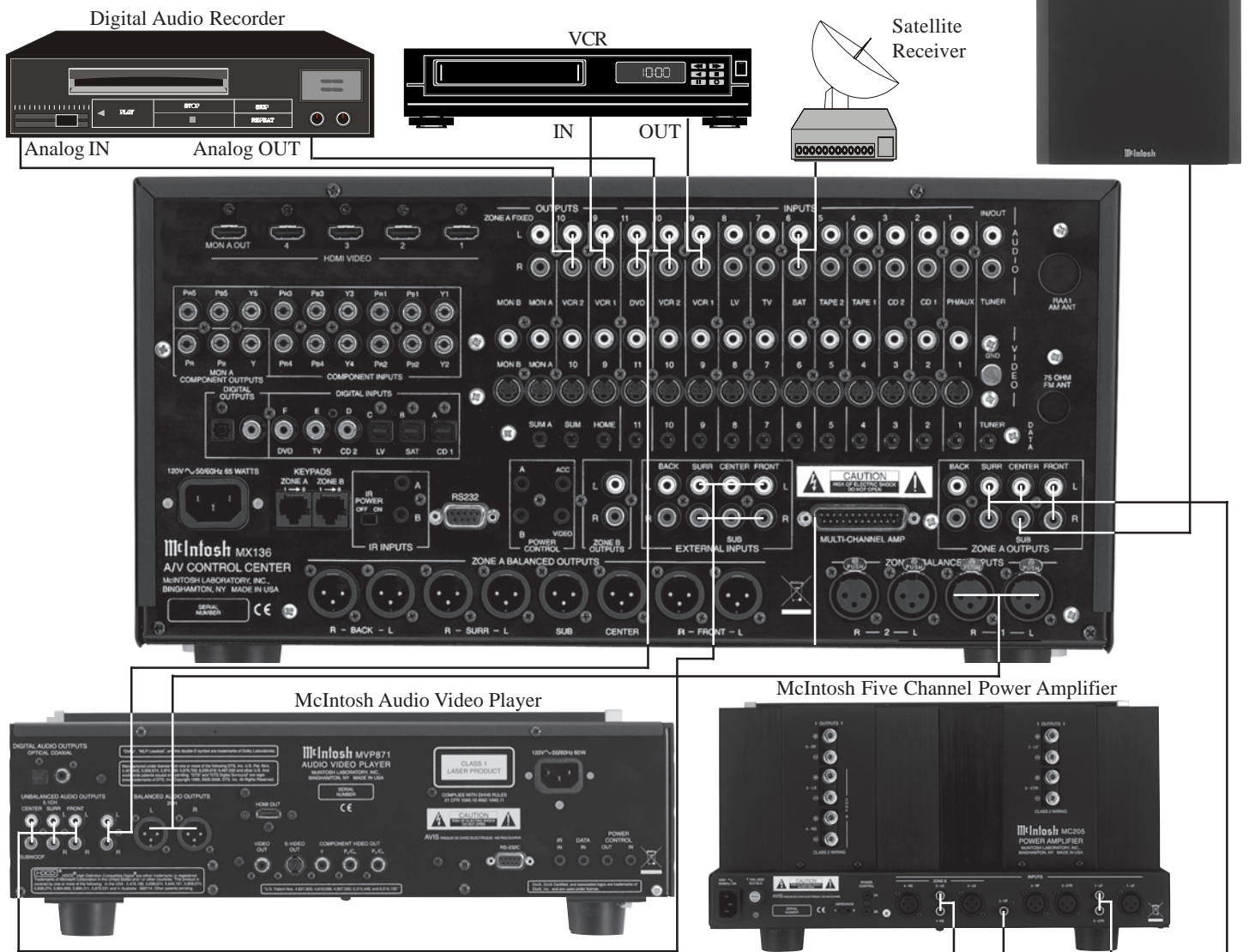



## How to Connect Analog Audio Components for eight channels

The MX136 accepts Analog Audio and Digital Audio Signal Inputs. It is important to connect the Analog Outputs along with the Digital Audio Signal Output from source components connected to the MX136. This will assure the audio from the source component is available to the REC Outputs and Zone B Outputs.

1. Connect balanced cables from the MX136 ZONE A BALANCED OUTPUTS to the McIntosh Seven Channel Power Amplifier Balanced Inputs, making sure to match up the channel identifications between both units.

*Note: In place of the Balanced Audio Cables, unbalanced cables or a DB25 cable may be used.*

2. Connect a cable from the MX136 Analog Audio INPUTS (Input 11) to the McIntosh 2 CH Audio Outputs of the McIntosh AUDIO VIDEO Player.
3. Connect balanced cables from the MX136 ZONE A BALANCED INPUTS 1 to the McIntosh Balanced Audio Outputs of the McIntosh AUDIO VIDEO Player.
4. Connect cables from the MX136 EXTERNAL Audio INPUTS to the McIntosh 5.1CH Audio Outputs of the McIntosh AUDIO VIDEO Player.
5. Connect a cable from the MX136 Left and Right Analog Audio INPUTS (Input 6) to the Left and Right Analog Audio Outputs of the Satellite Receiver.
6. Connect a cable from the MX136 VCR1 Audio OUTPUTS (Output 9) to the VCR Audio Input.
7. Connect a cable from the MX136 VCR1 Audio INPUTS (Input 9) to the VCR Audio Output.
8. Connect a cable from the MX136 LV Audio INPUTS (Input 8) to the Digital Audio Recorder Analog Output.
9. Connect a cable from the MX136 VCR2 Audio OUTPUTS (Output 10) to Digital Audio Recorder Analog Input.
10. Connect a cable from the MX136 ZONE A SUBwoofer OUTPUTS to the McIntosh Powered Subwoofer Line In Jack.

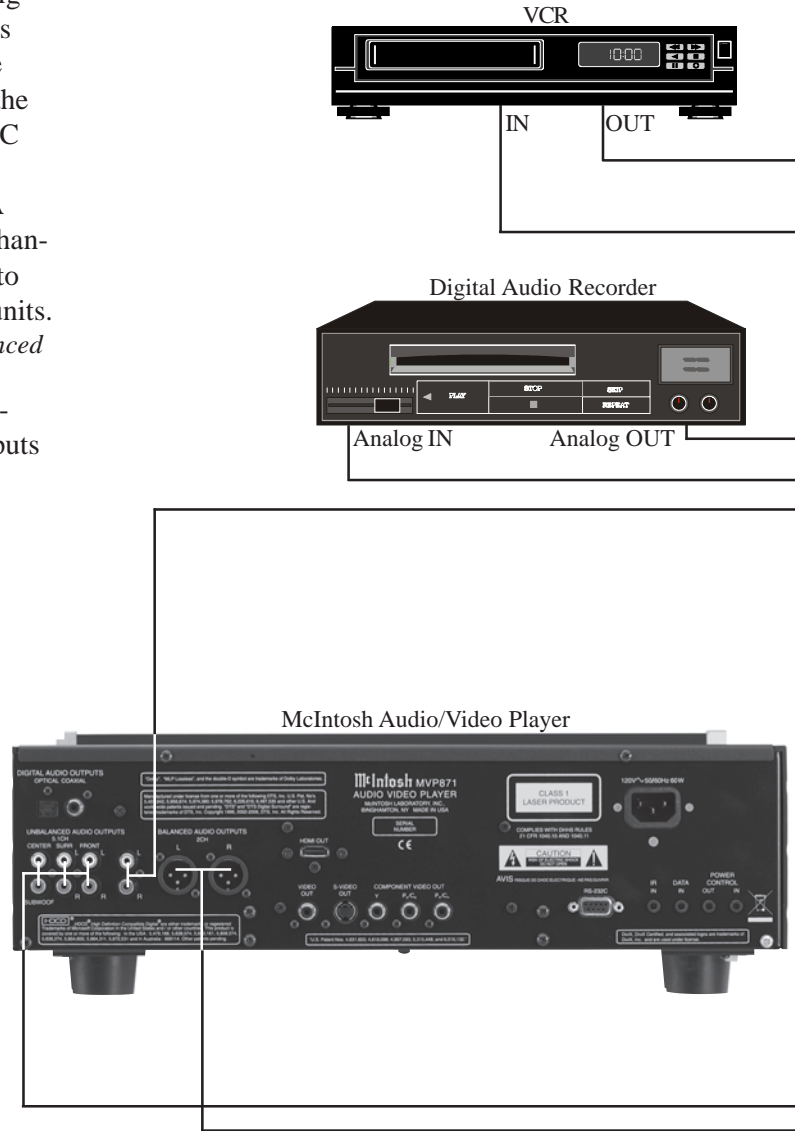



# How to Connect Analog Audio Components for eight channels

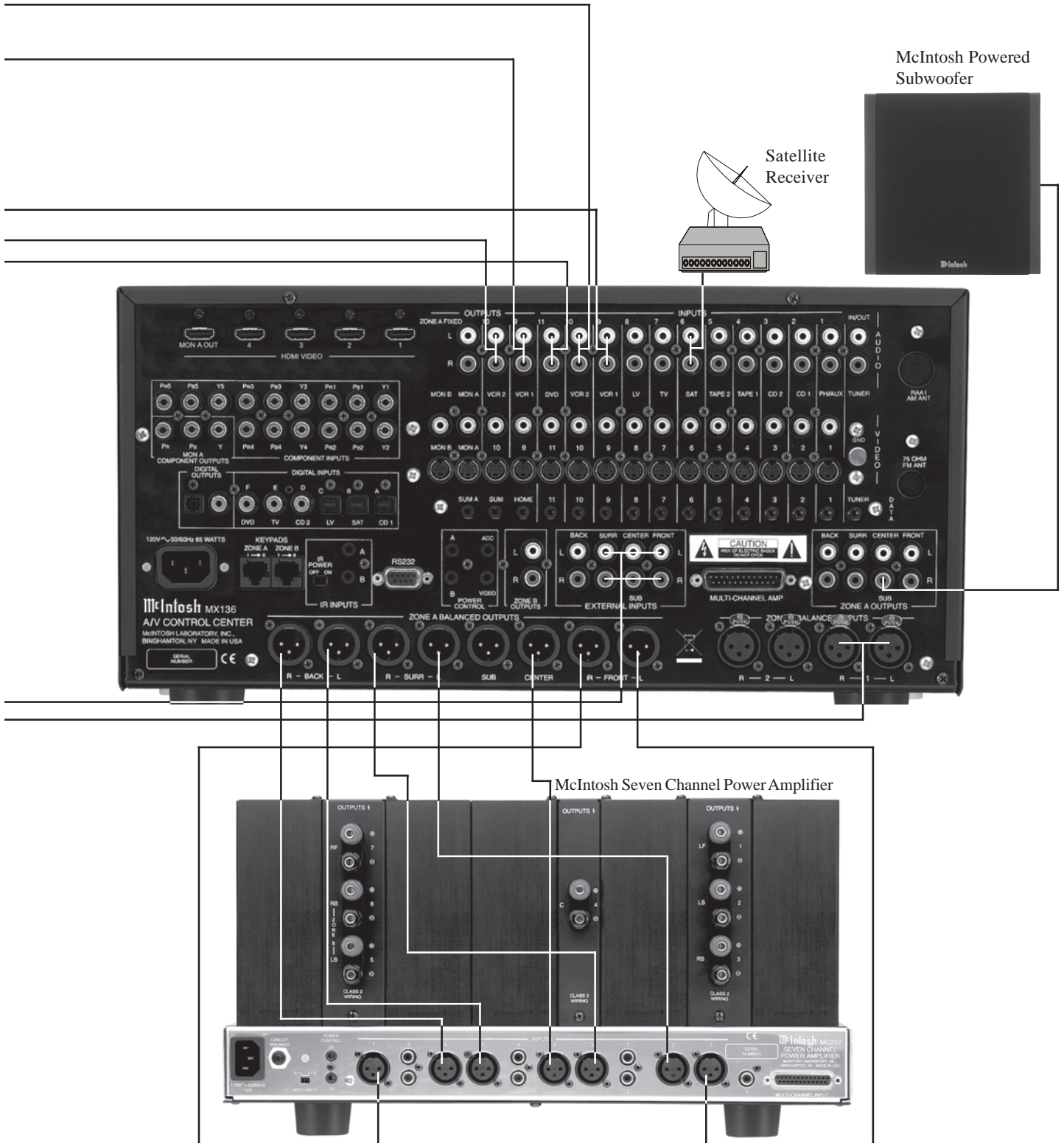

## How to Connect Video Components

There are four types of Video Signals the MX136 can select; Composite, S-Video, Component and HDMI. The built-in Digital Video Processing Circuitry can Up-Convert the desired Composite Input to S-Video; it will also Up-Convert the desired Composite, S-Video Inputs to Component Video or convert Component Video to HDMI. Connect all of the available Source Component Video Outputs (HDMI, Component, S-Video and Composite), using the appropriate Video Cables to the MX136. This will assure that video is available to the Zone B and RECOrd Outputs. Refer to Component Video Input and Video Converter Setup on page 34 for additional information.

1. Connect a HDMI cable from the MX136 HDMI 4 Video Input to the McIntosh HDMI Video Output of the McIntosh Audio Video Player.
2. Connect video cables from the MX136 DVD VIDEO INPUTS to the McIntosh Video Outputs of the McIntosh Audio Video Player.

3. Connect video cables from the MX136 DVD COMPONENT INPUTS 5 to the McIntosh Component Video Outputs of the McIntosh Audio Video Player.
4. Connect video cables from the MX136 SAT VIDEO INPUTS to the Video Outputs of a Satellite Receiver.
5. Connect video cables from the MX136 SAT COMPONENT INPUTS 1 to the Component Video Outputs of a Satellite Receiver.
6. Connect video cables from the MX136 VCR INPUTS to the VCR Video Outputs.
7. Connect video cables from the MX136 VCR RECORD OUTPUTS to the VCR Video Inputs.
8. Connect HDMI cables from the MX136 MON A HDMI VIDEO OUTPUT to the Monitor/TV HDMI Video Input.
9. Connect video cables from the MX136 MON A COMPONENT OUTPUTS to the Monitor/TV Component Video Inputs.

*Note: If the Monitor/TV does not have HDMI or Component Video Inputs, then connect the MX136 MON A S-Video or Composite Output(s) instead.*

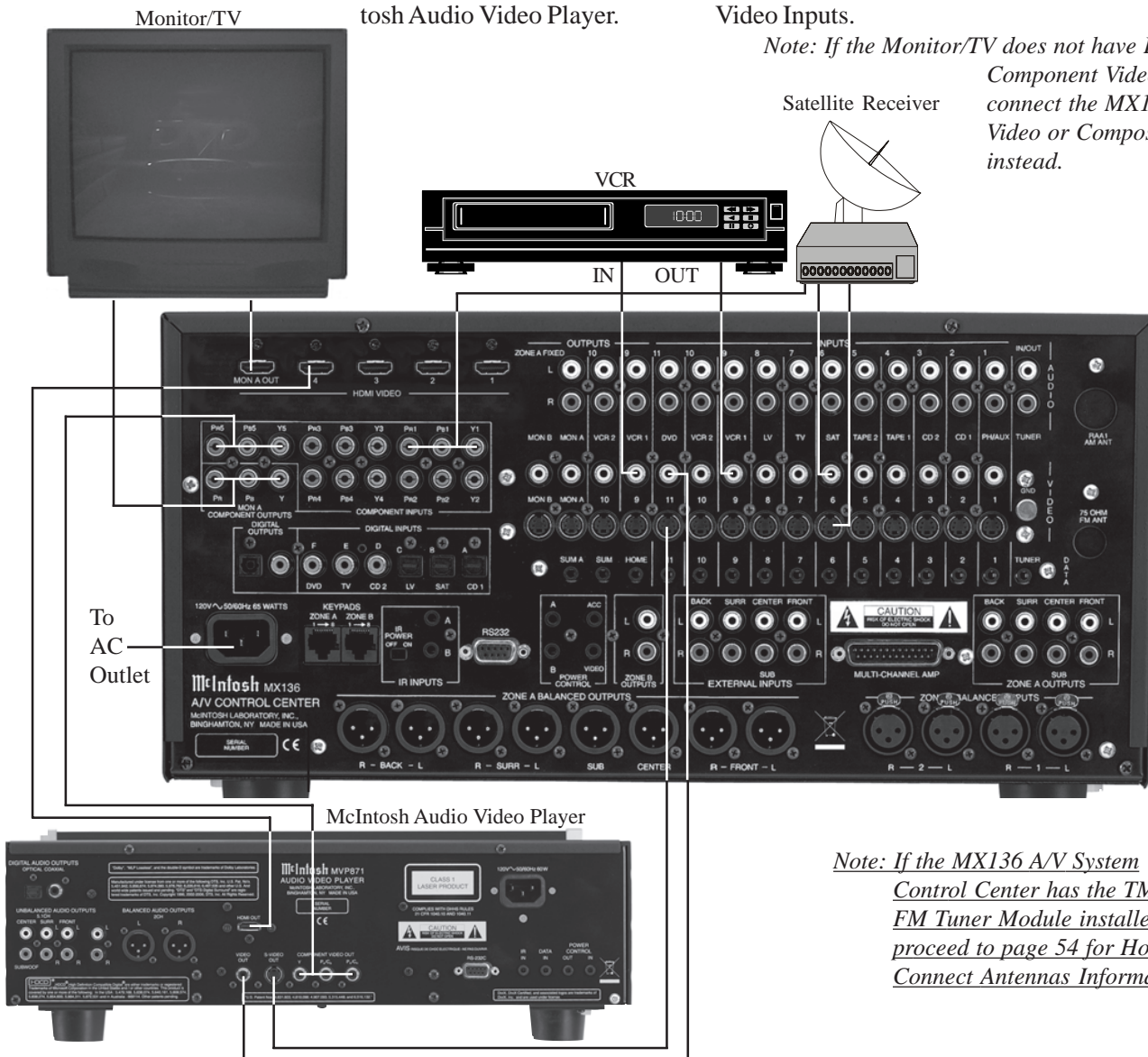

*Note: If the MX136 A/V System Control Center has the TMI AM/FM Tuner Module installed, proceed to page 54 for How to Connect Antennas Information.*





Allows up or down adjustment for each trim parameter

Selects which of the eleven Audio/Video Sources or Tuner Signal is available for VCR Outputs, Zone B Audio Outputs and MONitor B Video Outputs

Selects which of the eleven Audio/Video Sources or Tuner Signal is available at the Zone A Audio Outputs, Component and MONitor A Video Outputs

Adjusts the Listen Volume Level of all eight channels



IR (Infra Red) Sensor accepts IR signals directly from the Remote Control

Selects the parameter for making audio and front panel display adjustments

Selects the desired audio operating mode and selects the external eight channel input

Activates control of Zone B, both Input Selection and Volume Adjustment

Allows for the storing into memory various MX136 Settings

Switches On and Off Zones A or B, or resets all the MX136 microprocessors

Move Up or Down through various selections and for Tuning Up or Down the AM or FM Broadcast Band when the optional TM1 Tuner Module is installed



Switches Off the entire multizone system

Press to go into Setup Mode to change the settings

Allows for the selection of various MX136 Functions

Move Left or Right through selections and for scrolling through the Tuner Presets stored in memory, when the optional TM1 Tuner Module is installed

Activates the volume compression circuit, supported by selected Dolby Digital sound tracks

Switches all AC Power On or Off

Indicates which Trim Parameter has been selected

Indicates Input Selection Status, Volume, Trim Adjustments, Surround Modes, Setup Functions. The Tuner Functions are displayed when the Optional TM1 Module is installed

Indicates which Surround Mode is in use

Indicates the name of the Sound Processing Format that is in use for INPUT A (Listen) Selector and if it is receiving a DIGITAL SIGNAL

Indicates the Listen Output Format and which channels are active; L (Left Front), C (Center), R (Right Front), SUB (Subwoofer), LS (Left Surround), BS (Back Surround) and RS (Right Surround)



Indicates when Zone B Front Control is active

Indicates the Format of the Incoming Signal and which channels are active; L (Left Front), C (Center), R (Right Front), LFE (Low Frequency Effects), LS (Left Surround), S (Pro Logic Surround) and RS (Right Surround)

Indicates when the Late Night Processing has been selected

Indicates when the Input Source selected is processing a Digital Signal

Indicates when the MX136 is in Standby/On Mode

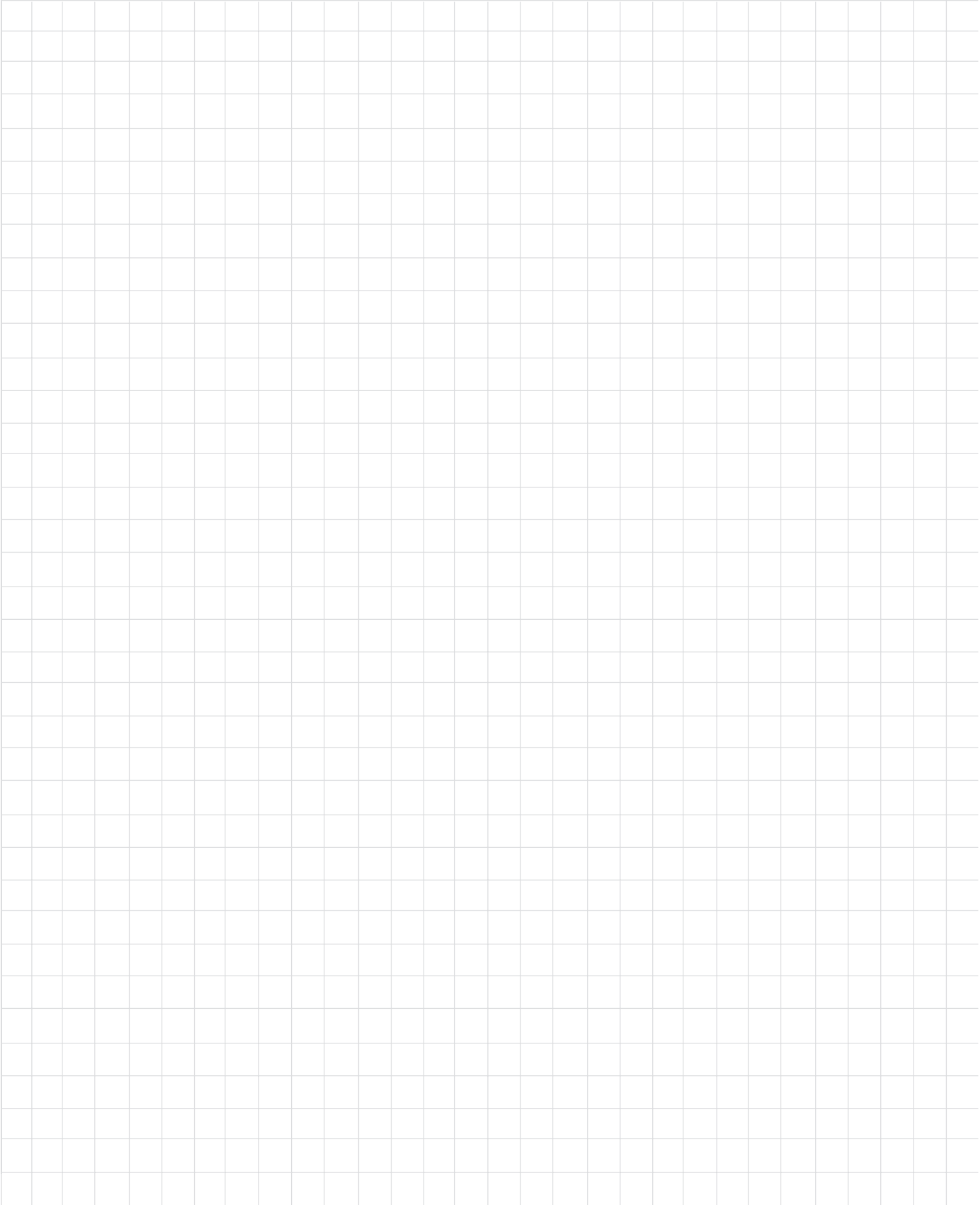

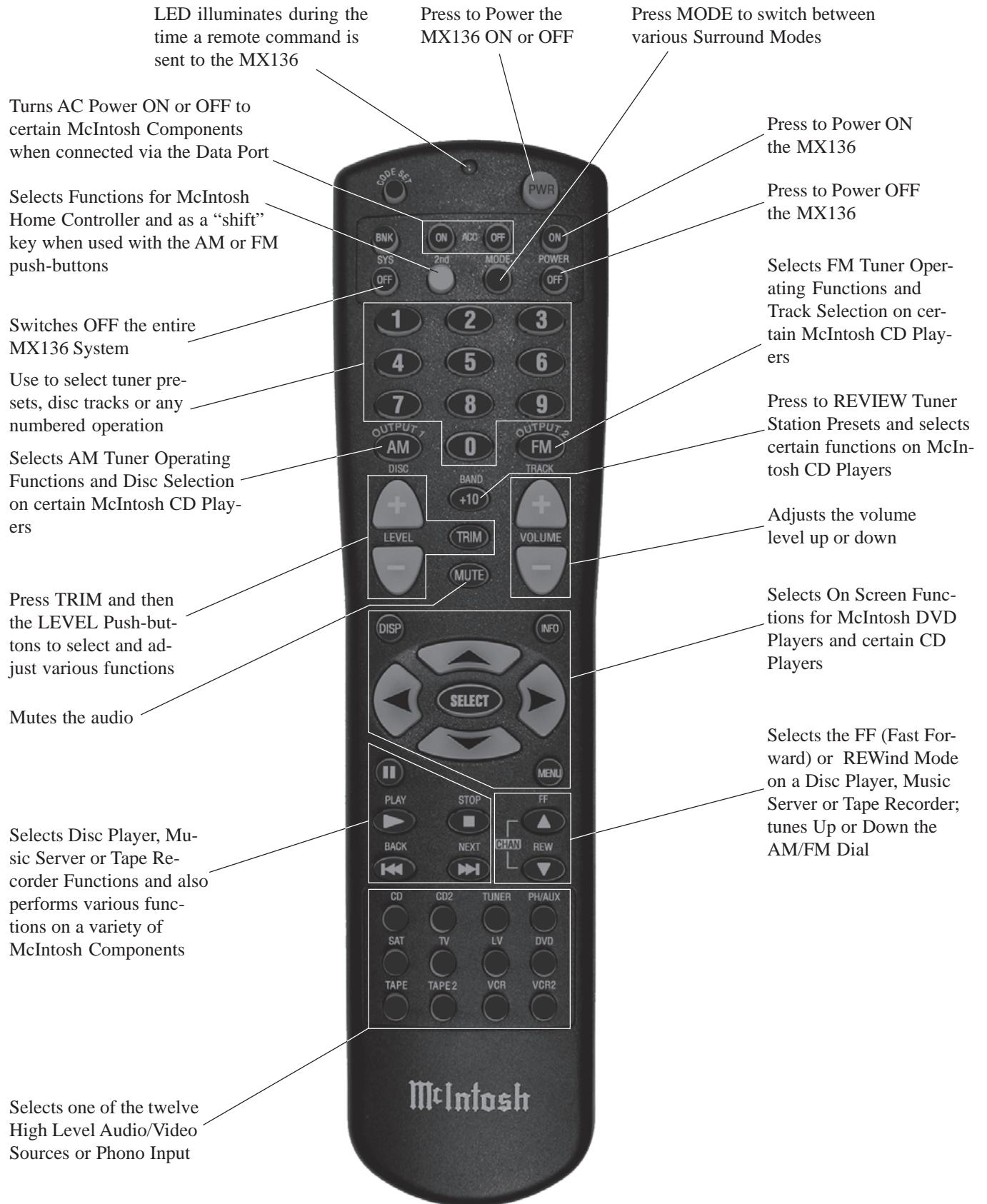

*Note: Push-buttons whose function is not identified above are for use with other McIntosh Products.*



### How to Operate by Remote Control

The supplied Remote Control is capable of directly controlling the functions of contemporary McIntosh Source Components connected to the MX136. Earlier McIntosh source components and other brand source components can be controlled by the MX136 Remote Control with the addition of a McIntosh Remote Control Translator (RCT).

*Note: Your McIntosh Dealer can assist you with the installation and operation of the Remote Control Translator (RCT).*

#### Mute

Press the MUTE Push-button to mute audio in the Zone where the command is issued. The VCR OUTPUTS are not affected by the MUTE function. The MX136 Front Panel Alphanumeric Display will indicate the word Mute for Zone A. Press MUTE a second time to unmute audio.

#### Mode

Press the MODE Push-button to select the Surround Mode from Mono to Cinema 2 plus External Mode for listening to an Eight Channel Analog Audio Source.

#### Trim

Press the TRIM Push-button, followed by the LEVEL Up▲ or Down▼ Push-button to select various sound adjustments and MX136 Setup Settings.

#### Input Source Selection

Press any of the twelve Input Push-buttons to select a program source, both audio and video.

#### Disc and Tape Functions

Use these push-buttons to operate a DVD Player, CD Player, CD Changer or Tape Recorder.

#### Numbered Push-buttons

Press Push-buttons 0 through 9 to access tuner station presets or CD tracks/discs.

#### Disc and Track

Use the DISC and TRACK Push-buttons when a CD Player or changer is being used.

#### Tuner Push-buttons

Press the AM or FM Push-button to select the desired broadcast band. Press and release the Channel Up▲ or Down▼ Push-button to move from station to station. Press and hold a Channel Up▲ or Down▼ Push-button to move continuously from station to station. Press +10 to start the automatic brief audition of each of the presets stored in the

tuner memory. Press +10 a second time to stop on a station preset and exit the Review process.

*Note: The above Tuner Function requires either the optional TMI Tuner Module installed in the MX136 or an external McIntosh Tuner connected to the MX136.*

#### Volume

Press the Up▲ or Down▼ VOLUME Push-button to raise or lower the listening volume level.

*Note: The VCR OUPUTS are not affected by volume changes.*

#### Acc On

Press ACC ON to turn the power ON to a McIntosh Disc Player.

#### Acc Off

Press ACC OFF to turn the power OFF to a McIntosh Disc Player.

#### Pause

Press|| to perform various functions on a variety of McIntosh Components. It will also pause the playing of a disc or tape player. The|| Push-button will also allow for quick exiting from the active menu when in the setup mode.



## How to Operate the Setup Mode

Your McIntosh MX136 has been factory configured with default operating settings allowing for immediate use. Changes to the default settings are accomplished with the built-in Setup Feature using On Screen Menus. Follow the sequence listed in the MAIN SYSTEM SETUP Menu, as some of these adjustments are interactive.

*Note: One of the MX136 MON A Video OUTPUTS must be connected to the video input of a Monitor/TV for viewing the On Screen Menus.*

1. Press the POWER switch to ON, the Red LED above the STANDBY/ON Push-button lights to indicate the MX136 is in Standby mode. Refer to figures 1 and 2.

*Note: When the MX136 Main POWER Switch is first switched ON, the Front Panel Alphanumeric Display will indicate MX-136 and the Front Panel Nomenclature will illuminate for about two seconds.*

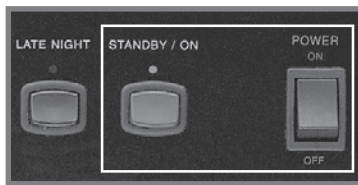

Figure 1

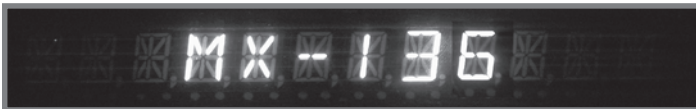

Figure 2

2. To Turn On the MX136, press the STANDBY/ON Push-button. During the circuitry initialization period (approximately four seconds) after turn-on, the Front Panel Alphanumeric Display will indicate the word MUTE (Audio Outputs will be muted). Refer to figures 1 and 3.



Figure 3

*Notes: For normal operation, switch the MX136 On and Off with the Standby/On Push-button. You may also switch the MX136 On and Off by using the supplied Remote Control. If the MX136 is not going to be used for an extended period of time, turn off all AC Power with the Power Switch.*

3. Press and hold the MX136 Front Panel SETUP Push-button for approximately three seconds to enter the Setup Mode. The word SETUP will appear on the Front Panel Alphanumeric Display and the MAIN SYSTEM SETUP Menu will appear on the Monitor/TV Screen. Refer to figures 4, 5 and 6.



Figure 4

4. Access the desired Setup Menu by pressing the Up▲ or Down▼ directional push-buttons followed by the SELECT/OK Push-button on the supplied Remote Control. The desired Setup Menu will then appear on the Monitor/TV Screen. Use the Up▲ or Down▼ directional push-buttons to SELECT/OK the menu item and press the Left◀ or Right▶ directional push-buttons to change the current setting.
5. After all adjustments are complete, select MAIN MENU by pressing the Up▲ or Down▼ directional push-buttons followed by SELECT/OK Push-button on the remote control.

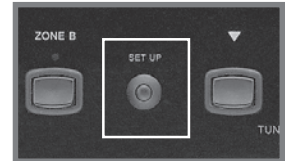

Figure 5



Figure 6

*Note: Exiting from the active menu may also be performed by pressing the EXIT Push-button on the Remote Control.*

6. If adjustments have been performed, the Adjustment Acceptance Menu will appear on the Monitor/TV screen asking if you want to save the adjustments in memory. Use the Up▲ or Down▼ directional push-buttons to select YES to save, or NO to not save, then press the SELECT/OK Push-button to exit the Setup Mode and return to normal operation. Refer to figure 7.

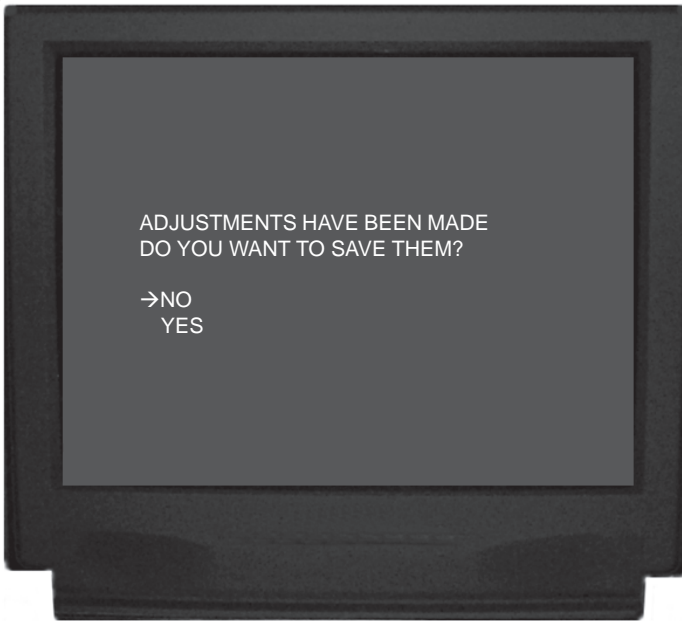

Figure 7

10 .....	VCR 2 .....	33
11 .....	DVD .....	33

**Digital Inputs (Zone A):**

<u>Letter</u>	<u>Type</u>	<u>Name</u>	<u>Refer to Page</u>
A .....	Optical .....	CD 1 .....	34
B .....	Optical .....	SAT .....	34
C .....	Optical .....	LV .....	34
D .....	Coaxial .....	CD 2 .....	34
E .....	Coaxial .....	TV .....	34
F .....	Coaxial .....	DVD .....	34

**Zone A Analog Input:**

<u>Number</u>	<u>Setting</u>	<u>Refer to Page</u>
0 - 11 .....	RCA .....	34

**Surr (Surround) Mode Default:**

<u>Number</u>	<u>Setting</u>	<u>Refer to Page</u>
0 - 11 .....	LAST .....	35

**Video Power Control:**

<u>Number</u>	<u>Power Control</u>	<u>Refer to Page</u>
0 - 11 .....	ON .....	35

**HDMI Video Inputs (Zone A):**

<u>Number</u>	<u>Name</u>	<u>Refer to Page</u>
1 .....	SAT .....	35
2 .....	TV .....	35
3 .....	VCR 1 .....	35
4 .....	DVD .....	35

**Component Video Inputs (Zone A):**

<u>Number</u>	<u>Name</u>	<u>Refer to Page</u>
1 .....	SAT .....	35
2 .....	TV .....	35
3 .....	VCR 1 .....	35
4 .....	VCR 2 .....	35
5 .....	DVD .....	35

**Volume Setup:**

<u>Description</u>	<u>Initial Setting</u>	<u>Refer to Page</u>
Zone A Volume Preset: .....	Last .....	38
Zone A Volume Maximum: .....	99 .....	38
Zone B Volume Preset: .....	20 .....	38
Zone B Volume Maximum: .....	99 .....	38

**Advanced Digital Settings:**

<u>Function</u>	<u>Setting</u>	<u>Refer to Page</u>
HDMI Output Format .....	AUTO .....	39
RC Toggle: .....	OFF .....	39

**Advanced Input Select Power:**

<u>Function</u>	<u>Setting</u>	<u>Refer to Page</u>
Input Select Power: .....	OFF .....	39

<sup>1</sup>The Low Frequency Effect (LFE) Sound Information is usually assigned to the Subwoofer Channel. If the Subwoofer Channel is switched Off and one or more of the Front Channel Loudspeakers are set to Large in the Speaker Size Setup Menu, the LFE Sound Information will be redirected to the Large Loudspeaker(s).

**Default Settings**

The following listings indicate the factory default settings. Refer to the listed page number for instructions on how to change a default setting:

**Speaker Size:**

<u>Speaker Type</u>	<u>Speaker Setting</u>	<u>Refer to Page</u>
Front .....	Small .....	28
Center .....	Small .....	28
Surround .....	Small .....	28
Back Surr .....	Small2 .....	28
Subwoofer <sup>1</sup> .....	Yes .....	28
Sub Xover .....	80Hz .....	28
MC Bass Mode .....	Off .....	28

**Speaker Time Delay:**

<u>Speaker Location</u>	<u>Viewing Distance</u>	<u>Refer to Page</u>
All Locations .....	10 feet .....	30

**Speaker Level:**

<u>Speaker Location</u>	<u>Initial Level</u>	<u>Refer to Page</u>
All Locations .....	0 .....	31

**Analog Inputs (Zones A and B):**

<u>Number</u>	<u>Name</u>	<u>Refer to Page</u>
0 .....	TUN .....	33
1 .....	PH/AUX .....	33
2 .....	CD1 .....	33
3 .....	CD2 .....	33
4 .....	TAPE 1 .....	33
5 .....	TAPE 2 .....	33
6 .....	SAT .....	33
7 .....	TV .....	33
8 .....	LV .....	33
9 .....	VCR 1 .....	33



## How to Adjust for Loudspeaker Size

A Home Theater System can include a variety of Loudspeakers with various capabilities. The LARGE listing refers to the Loudspeaker's capability for reproducing bass frequencies down to 35Hz within -3dB of the midrange frequencies. If a Loudspeaker can not reproduce bass frequencies down to 35Hz within -3dB of the midrange frequencies, it is considered SMALL. If you do not have a Subwoofer, you must have Front (Left and Right) Loudspeakers that are LARGE in order to hear the low frequencies below the Subwoofer Crossover Setting of 80Hz. If you are unsure as to the bass performance capabilities of your Loudspeakers, select the SMALL setting.

1. Press and hold the Front Panel SETUP Push-button for approximately three seconds to enter the Setup Mode. The word SETUP will appear on the MX136 Front Panel Alphanumeric Display and the MAIN SYSTEM SETUP Menu will appear on the Monitor/TV screen. Refer to figure 6 on page 26.

2. Using the Up▲ or Down▼ directional push-buttons, select Speaker Size on the On-Screen Menu, followed by the SELECT/OK Push-button on the Remote Control. Refer to figure 8.

*Notes: The very first time the SPEAKER SIZE Menu is accessed, the factory default settings will be indicated. In the Speaker Size Menu Setting Options, the number after the name of Small or Large refers to quantity of Loudspeakers. If the setting for the Back Surround Loudspeaker is Small 1 (BSL - Back Surround Left), only the Zone A Back Output Left Channel will have audio output.*

3. Select the appropriate Loudspeaker location and type by using the Up▲ or Down▼ directional push-buttons to select first the menu item and then press the Left◀ or Right▶ directional push-buttons to change the current setting.

*Notes: When the Front Loudspeakers are set to Small, the options in the Speaker Size Setup Menu for the Center and Surround Loudspeakers are Small or None; the Subwoofer Loudspeaker will be set to the On position. If the Surround Loudspeakers are set to Small, the options in the Speaker Size Setup Menu for the Back Surround Loudspeaker are Small 1(BSL), Small 2 or None. When the Small 1 (BSL) setting is selected, the BACK Surround Right Channel ZONE A OUTPUT will be switched Off. A chart has been provided on the next page to record your system settings.*



Figure 8

4. When all of the settings on the SPEAKER SIZE Menu agree with the Loudspeakers in your Home Theater System, perform the SUB Crossover and/or the MC BASS MODE adjustments or if no adjustments are needed, then continue to the SPEAKER TIME DELAY Settings. If you do not wish to perform SPEAKER TIME DELAY adjustments at this time, select MAIN MENU from the menu. The MAIN SYSTEM SETUP Menu will reappear on the Monitor/TV screen and proceed to the next step.
5. Select EXIT from the MAIN SYSTEM SETUP Menu. If you are satisfied with the changes that you have made, select YES to save those changes or NO not to save them. The MX136 will then return to normal operation. Refer to figure 7 on page 27.

**Sub Crossover**

The MX136 incorporates a built-in Electronic Crossover. The Crossover will redirect all of the audio frequencies below the crossover frequency setting to the Subwoofer and all the frequencies above the setting to the appropriate remaining Home Theater Loudspeakers. The default setting for the SUB Crossover frequency setting is 80 Hz, which is the correct frequency for most Home Theater Loudspeaker Systems. Refer to figure 8 and perform the following steps to change the setting.

- Using the Up▲ or Down▼ directional push-buttons, select SUB Crossover from the SPEAKER SIZE On-Screen Menu, followed by pressing the Left◀ or Right▶ directional push-buttons to change the crossover frequency to the desired setting.

*Notes: The range of adjustment is from 60Hz to 120Hz in 10Hz increments. When the Input Source is Analog and the Surround Mode is set to STEREO (the Alphanumeric Front Panel Display will indicate PURE STEREO) the crossover frequency will default to 80Hz.*

- Next perform the MC Bass Mode adjustment below or if no adjustment is needed, then continue to the SPEAKER TIME DELAY Settings. If you do not wish to perform SPEAKER TIME DELAY adjustments at this time, select MAIN MENU from the menu. The MAIN SYSTEM SETUP Menu will reappear on the Monitor/TV screen and proceed to the next step.
- Select EXIT from the MAIN SYSTEM SETUP Menu. If you are satisfied with the changes that you may have made, select YES to save those changes or NO not to save them. The MX136 will then return to normal operation. Refer to figure 7 on page 27.

**MC Bass Mode**

When a Home Theater System contains Loudspeakers that are referred to as Large, the Bass Management Circuitry will direct all the Low Frequency Sounds away from the Subwoofer and to the Large Loudspeakers. With the MC BASS MODE set to ON the Low Frequency Sounds are sent to both the Large Loudspeakers and to the Subwoofer, thus increasing the total low frequency output of the Home Theater System. The default setting for the MC BASS MODE is OFF. Refer to figure 8 and perform the following steps to switch it On.

*Note: The MC BASS Mode is only active when the Source is either a Two Channel Analog or Digital Signal.*

- Using the Up▲ or Down▼ directional push-buttons, select MC BASS MODE from the SPEAKER SIZE On-Screen Menu, followed by pressing the Left◀ or Right▶ directional push-buttons to activate the circuit. Select MAIN MENU and the MAIN SYSTEM SETUP Menu will reappear on the Monitor/TV screen.
- Next continue to the SPEAKER TIME DELAY Settings. If you do not wish to perform SPEAKER TIME DELAY adjustments at this time, select MAIN MENU from the menu. The MAIN SYSTEM SETUP Menu will reappear on the Monitor/TV screen and proceed to the next step.
- Select EXIT from the MAIN SYSTEM SETUP Menu. If you are satisfied with the changes that you have made, select YES to save those changes or NO not to save them. The MX136 will then return to normal operation. Refer to figure 7 on page 27.

Loudspeaker Size		
Loudspeaker	Default Setting	New Setting
Front (L&R)	Small	
Center	Small	
Surround (L&R)	Small	
Back Surround	Small 2	
Subwoofer	Yes	
Sub Crossover	80Hz	
MC Bass	Off	

## How to Adjust Loudspeaker Time Delay

The following Time Delay Adjustments will electronically compensate for different Loudspeaker distances from the Listening/Viewing Area. Refer to figure 9. Time delay is measured in feet. The delays can be adjusted from 1 foot to 20 feet in one foot increments for each Loudspeaker.

*Note: Before performing the TIME DELAY adjustments, you must first have completed the SPEAKER SIZE adjustments.*

1. Press and hold the Front Panel SETUP Push-button for approximately three seconds to enter the Setup Mode. The word SETUP will appear on the MX136 Front Panel Display and the MAIN SYSTEM SETUP Menu will appear on the Monitor/TV screen. Refer to figure 6 on page 26.
2. Using the Up▲ or Down▼ directional push-buttons, select SPEAKER TIME DELAY on the On-Screen Menu, followed by the SELECT/OK Push-button on the Remote Control. Refer to figure 10.

*Note: The very first time the SPEAKER TIME DELAY MENU is accessed, the factory default settings will be indicated.*

3. Measure the distance from the Listening/Viewing Area to each of the Loudspeakers. A table has been provided to record the measurements and settings.

*Note: A distance measurement that contains fractions of a foot, should be rounded up or down to the nearest whole number for this procedure.*

4. Select the appropriate Loudspeaker location and type by using the Up▲ or Down▼ directional push-buttons to select first the menu item and then press the Left◀ or Right▶ directional push-buttons to change the current

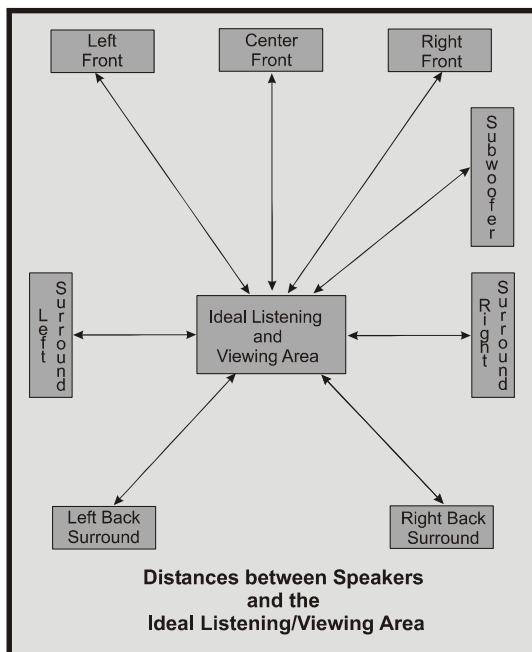

Figure 9

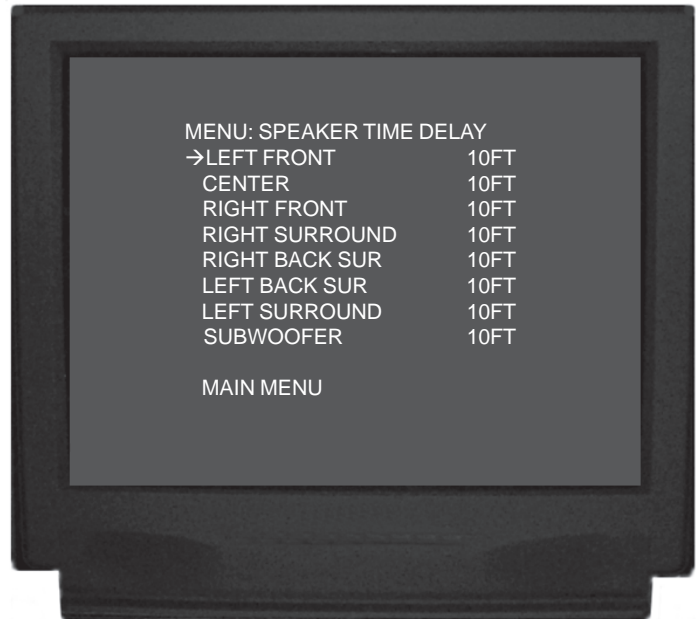

Figure 10

setting. When all of the settings on the SPEAKER TIME DELAY Menu agree with the Loudspeaker measured distances in your Home Theater System, select MAIN MENU. The MAIN SYSTEM SETUP Menu will reappear on the Monitor/TV screen.

5. Continue next to the SPEAKER LEVEL Settings. If you do not wish to perform SPEAKER LEVEL Adjustments at this time, select MAIN MENU from the menu. The MAIN SYSTEM SETUP Menu will reappear on the Monitor/TV screen and proceed to the next step.
6. Select EXIT from the MAIN SYSTEM SETUP Menu. If you are satisfied with the changes that you have made, select YES to save those changes or NO not to save them. The MX136 will then return to normal operation. Refer to figure 7 on page 27.

Loudspeaker Time Delay		
Location	Default Setting	New Setting
Left Front	10 feet	
Center	10 feet	
Right Front	10 feet	
Right Surround	10 feet	
Right Back Sur	10 feet	
Left Back Sur	10 feet	
Left Surround	10 feet	
Subwoofer	10 feet	

## How to Adjust Loudspeaker Levels

A properly setup Home Theater Surround Sound System will have all Loudspeaker levels adjusted to the same volume level in the Listening/Viewing Area. The MX136 includes a built-in test signal generator and its output is switched into each Loudspeaker, either automatically or manually. The correct volume level for each Loudspeaker can be determined in the Listening/Viewing area, either with a sound pressure meter or by listening. Level adjustments are made in 1dB steps, over a plus or minus 12dB range, by using the Remote Control Left◀ and Right▶ directional push-buttons.

*Notes: Before adjusting the SPEAKER LEVELS, perform the SPEAKER SIZE and SPEAKER TIME DELAY adjustments first. The SPEAKER LEVEL On-Screen Display will only indicate channels that have been switched On in the SPEAKER SIZE Menu. A sound level pressure meter will greatly aid in adjusting the Loudspeaker levels and the Left Front Loudspeaker Volume level can serve as a reference.*

1. Press and hold the Front Panel SETUP Push-button approximately three seconds to enter the Setup Mode. The word SETUP will appear on the MX136 Front Panel Display and the MAIN SYSTEM SETUP Menu will appear on the Monitor/TV screen. Refer to figure 6 on page 26.
2. Using the Up▲ or Down▼ directional push-buttons, select SPEAKER LEVEL on the On-Screen Menu, followed by the SELECT/OK Push-button on the Remote Control. Refer to figure 11.  
*Note: The very first time the SPEAKER LEVEL MENU is accessed, the factory default settings will be indicated.*
3. Determine whether you wish to use the Automatic (requires less push-button presses) or Manual (quicker when used with a sound pressure meter) Loudspeaker Level switching mode. For Automatic switching, proceed to Step 4. For Manual switching, proceed to Step 11 on the next page.

### Automatic Loudspeaker Level Switching

4. Using the Left◀ or Right▶ directional push-buttons, select AUTO MODE from the SPEAKER LEVEL On-Screen Menu, followed by pressing the SELECT/OK Push-button to activate the Automatic Loudspeaker Level Switching Mode. The test signal will start cycling continuously through all Loudspeakers in 2-second intervals. Refer to figure 12.
5. While in the Listening/Viewing area, note the volume levels from each of the Loudspeakers as the test signal switches. If you determine that the test signal volume is



Figure 11

louder or softer in any of the Loudspeakers, the levels should be adjusted so you hear the same test signal volume from all of the Loudspeakers.

6. Adjust the volume of the test signal by pressing the Left◀ or Right▶ directional push-buttons on the Remote Control. If an adjustment is made on a Loudspeaker, there is an additional 2-second time interval before the system switches to the next Loudspeaker. As a level is changed, the on-screen display instantly indicates the level change with numbers or minus numbers.
7. As the test signal switches to succeeding Loudspeakers,

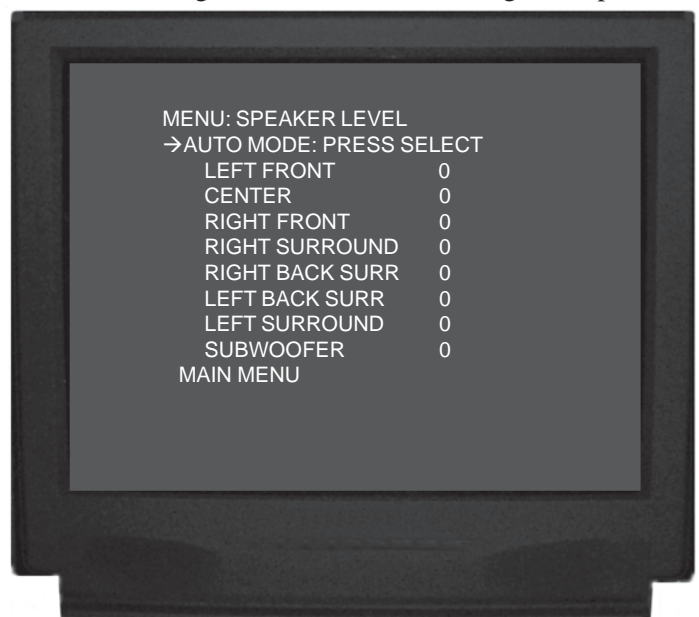

Figure 12



Figure 13



Figure 14

repeat the level adjustment process until the test signal volume levels of all the Loudspeakers are the same. The Loudspeaker level cycling mode can be repeated as often as necessary.

8. Press the SELECT/OK Push-button to switch Off the Automatic Loudspeaker Level Switching Mode. Refer to figure 13.
9. Continue next to the INPUT SETUP. If you do not wish to perform INPUT SETUP Adjustments at this time, select MAIN MENU from the menu. The MAIN SYSTEM SETUP Menu will reappear on the Monitor/TV screen and proceed to the next step.
10. Select EXIT from the MAIN SYSTEM SETUP Menu. If you are satisfied with the changes that you may have made, select YES to save those changes or NO not to save them. The MX136 will then return to normal operation. Refer to figure 7 on page 27.

#### Manual Loudspeaker Level Switching

11. Using the Left◀ or Right▶ directional push-buttons, select MANUAL MODE from the SPEAKER LEVEL On-Screen Menu, followed by pressing the SELECT/OK Push-button to activate the Manual Loudspeaker LEVEL Switching Mode. Refer to figure 14.
12. Adjust the volume of the Loudspeaker by pressing the Left◀ or Right▶ directional push-buttons on the Remote Control.
13. Using the Up▲ or Down▼ directional push-buttons, select the next Loudspeaker and perform the level adjusting procedure. Continue this for each of the remain-

ing Loudspeakers. Repeat this as often as necessary until you are satisfied that the volume levels of all the Loudspeakers are the same.

14. Press the SELECT/OK Push-button to switch Off the Manual Loudspeaker Level Switching Mode.
15. Continue next to the INPUT SETUP. If you do not wish to perform INPUT SETUP Adjustments at this time, select MAIN MENU from the menu. The MAIN SYSTEM SETUP Menu will reappear on the Monitor/TV screen and proceed to the next step.
16. Select EXIT from the MAIN SYSTEM SETUP Menu. If you are satisfied with the changes that you may have made, select YES to save those changes or NO not to save them. The MX136 will then return to normal operation. Refer to figure 7 on page 27.

Loudspeaker Levels		
Location	Default Setting	New Setting
Left Front	0dB	
Center	0dB	
Right Front	0dB	
Right Surround	0dB	
Right Back Sur	0dB	
Left Back Sur	0dB	
Left Surround	0dB	
Subwoofer	0dB	



## How to Change the Input Setup

The MX136 has twelve Analog Audio Inputs numbered 0 through 11, six Digital Audio Inputs lettered A through F and five Component Video Inputs numbered 1 through 5. There are also four HDMI (Digital Video) Inputs numbered 1 through 4. These inputs already have assigned titles and associations that will allow for immediate hookup, operation and enjoyment.

If these starting assignments and associations do not match up with components in your system, they may be reassigned from the default settings. The following example will illustrate how to rename the TAPE2 Input to DVD2 and assign it the LV Digital Input. When the Zone A or B Input Selector is rotated to select what was originally the TAPE2 Input, DVD2 will now appear on the Front Panel Alphanumeric Display. The Surround Mode, Video Power Control, HDMI Video and Component Video can also be set for each Input.

- Notes:*
1. The very first time the INPUT SETUP is accessed, the default settings will be indicated.
  2. Unused Inputs may be switched Off so that they will not appear when rotating through the input source choices using the Zone A or Zone B Input Selector and also will not be available when using the Remote Control or Keypad.

1. Press and hold the Front Panel SETUP Push-button approximately three seconds to enter the Setup Mode. The word SETUP will appear on the MX136 Front Panel Display and the MAIN SYSTEM SETUP Menu will appear on the Monitor/TV screen. Refer to figure 6 on page 26.
2. Using the Up▲ or Down▼ directional push-buttons on the Remote Control, select INPUT SETUP on the On-Screen Menu, followed by the SELECT/OK Push-button. Refer to figure 6 on page 26.
3. Using the Up▲ or Down▼ directional push-buttons, select SOURCE INPUT from the On-Screen Menu, followed by pressing the Left◀ or Right▶ directional push-buttons to select Input Number 5 - IR-TP2. Refer to figure 15.

*Note: The information displayed after the Source Input Number indicates which IR Remote Control Command selects the input.*

### Analog Audio/Video Input Title

4. Using the Up▲ or Down▼ directional push-buttons, select TITLE, followed by pressing the SELECT/OK Push-button. The On-Screen Menu Title can now be changed from the default name. Refer to figure 16.
5. Using the Up▲ or Down▼ directional push-buttons, select "D" as the first character of the new title.

*Note: The TITLE may be up to 4 characters in length including (0 thru 9) and (A thru Z).*

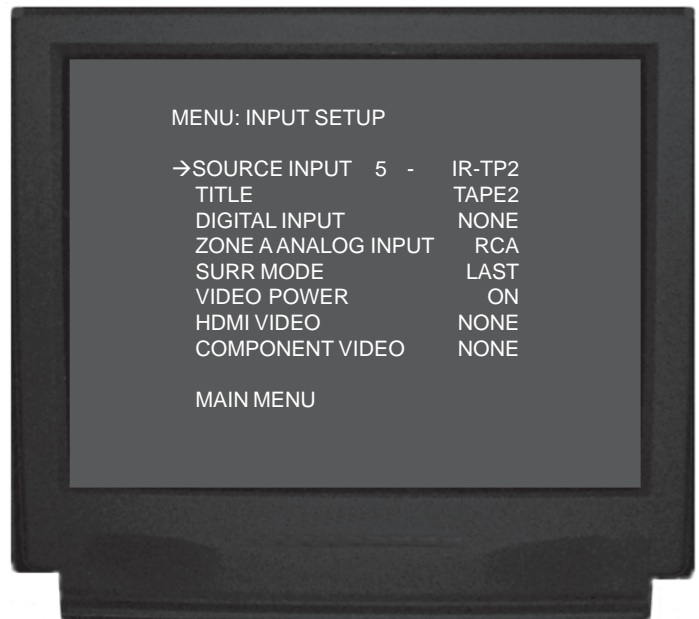

Figure 15

6. Press the Right▶ directional push-button to select the second character position of the title.
7. Using the Up▲ or Down▼ directional push-buttons to select "V" the second character of the title.
8. Select the two remaining characters "D" and "2" of the title by using the directional push-buttons.
9. Press the SELECT/OK Push-button once and then press the Down▼ directional push-button.
10. Proceed to the Digital Input Setting. If you do not wish to perform Digital Input Setting at this time, proceed to the ZONE A Analog Input Setting.

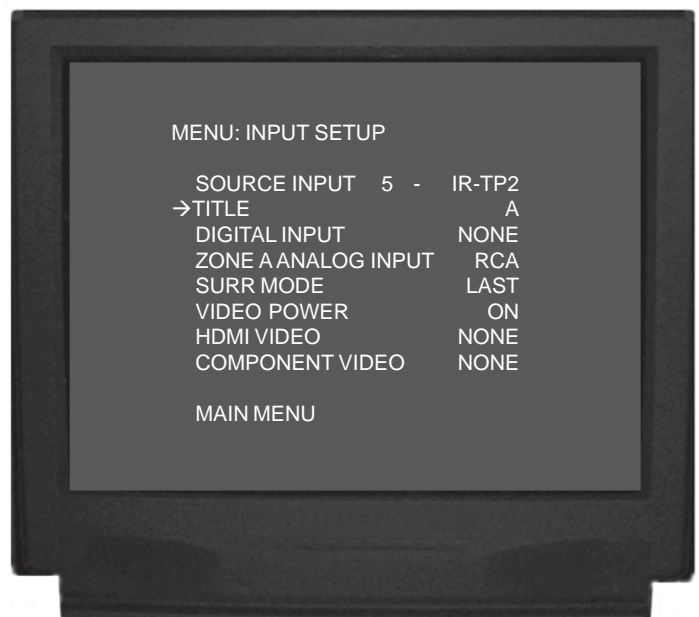

Figure 16

## Digital Input

There are three Optical Digital Inputs and three Coaxial Digital Inputs available for assignment with any of the twelve Analog Audio/Video Inputs. The following example describes how to reassign Digital Input C, which by default has been assigned to Input Number 8 LV, over to the newly created DVD2 Input instead.

11. Using the Up▲ or Down▼ directional push-buttons, select SOURCE INPUT from the On-Screen Menu, followed by pressing the Left◀ or Right▶ directional push-buttons to select the DVD2 Input Number 5.
12. Using the Up▲ or Down▼ directional push-buttons, select DIGITAL INPUT on the On-Screen Menu, followed by pressing the Left◀ or Right▶ directional push-buttons to select the OPT C LK Digital Input. Refer to figure 17.

*Notes: A Digital Input may be assigned to multiple Audio Inputs. The “LK” after the Digital Input Name indicates the MX136 will stay locked into the Digital Mode even with an interruption of the Signal. When the Lock is Off, the MX136 will switch to the associate Analog Input Signal if there is interruption of the Digital Signal.*

13. Continue next to the ZONE A Analog Input Setting. If you do not wish to perform ZONE A Analog Input Setting at this time, proceed to the SURR MODE setting.

## ZONE A Analog Input

The MX136 has two pairs of Stereo Balanced Inputs that may be assigned to any of the eleven Audio Inputs instead of unbalanced (RCA Type) jacks. The AUX Input also includes the option of connecting a Turntable with a Moving Magnet type Phono Cartridge to PH/AUX unbalanced jacks. In the steps below, the BALANCED 1 Inputs will be assigned to the DVD Input and the PH/AUX Input will change over to a Phono Input.

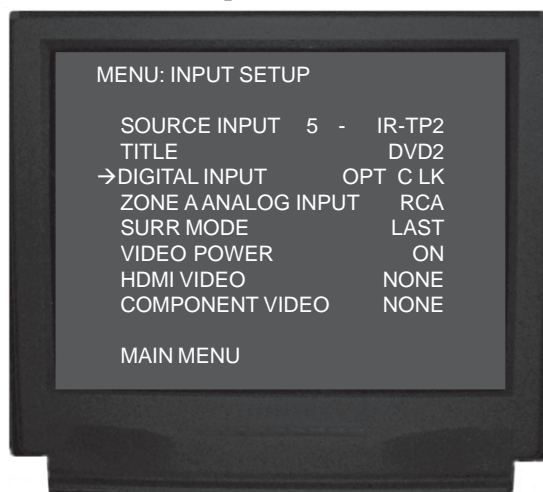

Figure 17

14. Using the Up▲ or Down▼ directional push-buttons, select SOURCE INPUT from the On-Screen Menu, followed by pressing the Left◀ or Right▶ directional push-buttons to select the DVD Input Number 11.
15. Using the Up▲ or Down▼ directional push-buttons, select ZONE A ANALOG INPUT on the On-Screen Menu, followed by pressing the Right▶ directional push-button to select BAL1. Refer to figure 18.  
*Note: The BALANCED (1 or 2) Input may be assigned to multiple Audio Inputs.*
16. Using the Up▲ or Down▼ directional push-buttons, select SOURCE INPUT from the On-Screen Menu, followed by pressing the Left◀ or Right▶ directional push-buttons to select the PH/AUX Input Number 1.
17. Using the Up▲ or Down▼ directional push-buttons, select ZONE A ANALOG INPUT on the On-Screen Menu, followed by pressing the Right▶ directional push-button to select the PHON. Refer to figure 19.
18. Using the Up▲ or Down▼ directional push-buttons, select TITLE, followed by pressing the SELECT/OK Push-button. The On-Screen Menu Title can now be changed from the default name.
19. Using the Up▲ or Down▼ directional push-buttons, select “P” as the first character of the new title.
20. Press the Right▶ directional push-button to select the second character position of the title.
21. Using the Up▲ or Down▼ directional push-buttons to select “H” the second character of the title.
22. Select the two remaining characters “O” and “N” of the title by using the directional push-buttons.
23. Press the SELECT/OK Push-button once and then press the Down▼ directional push-button.
24. Continue next to the SURR MODE Input Setting. If you do not wish to perform SURR MODE Input Setting at this time, proceed to the Video Power.

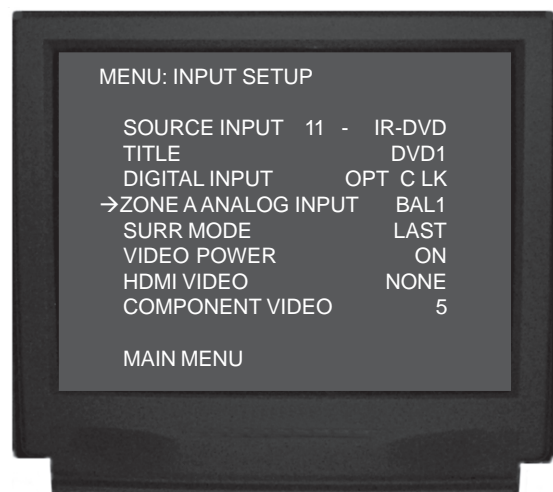

Figure 18



Figure 19



Figure 20

### Surround Mode

By default, the MX136 will remember the last Surround Mode Setting for each input. It is also possible to assign a Default Surround Mode for each Input, so every time that Input is selected the Surround Mode will be the default setting instead of the last selected Surround Mode for the input. Refer to figure 20.

25. Using the Up▲ or Down▼ directional Push-buttons, select SURR MODE from the On-Screen Menu, followed by pressing the Left◀ or Right▶ directional Push-buttons to select the CINEMA 1 Surround Mode for DVD Input instead of the default setting of LAST.
26. Continue next to the VIDEO POWER Control. If you do not wish to perform VIDEO POWER Control Adjustments at this time, proceed to the HDMI Video Input.

### Video Power

The MX136 has a VIDEO POWER CONTROL Jack and its activation is controllable by selecting any one of the Analog Audio/Video Inputs. By default all eleven Analog Audio/Video Inputs have the VIDEO POWER feature set to the ON Position. In the following example, the VIDEO POWER Setting for the new DVD Input will be switched Off.

27. Using the Up▲ or Down▼ directional push-buttons, select SOURCE INPUT from the On-Screen Menu, followed by pressing the Left◀ or Right▶ directional push-buttons to select the DVD Input Number 5.
28. Using the Up▲ or Down▼ directional push-buttons, select VIDEO POWER on the On-Screen Menu, followed by pressing the Left◀ or Right▶ directional



Figure 21

push-buttons to select OFF. Refer to figure 21.

29. If you do not wish to perform HDMI VIDEO Input Adjustments at this time, proceed to Component Video and Video Converter Input.

### HDMI Video Input

The MX136 has Electronic Input Switching for four HDMI Video Sources and they may be assigned to any of the eleven Analog Audio/Digital Inputs. The following example describes how to reassign HDMI 2 IN Video Input, which by default has been assigned to TV Input 7, over to the CD2 Input 3.

*Notes: The MX136 allows for assigning a HDMI Video Input to multiple Inputs or switched Off. If there are any Component Video, S-Video or Composite Video Inputs to be viewed through the HDMI Video Monitor A Output, it is necessary to select "COMP" in the HDMI Video Menu Selection for that Input Source.*

30. Using the Up▲ or Down▼ directional push-buttons,



Figure 22A

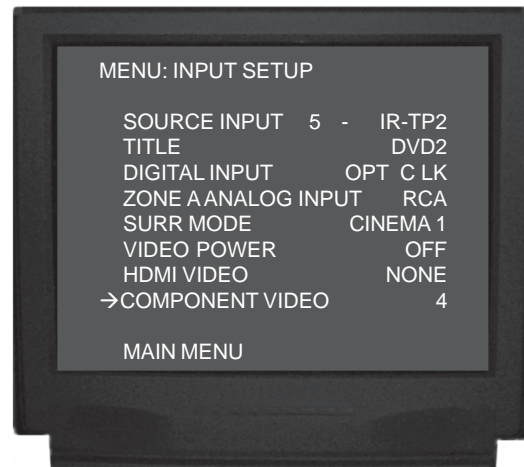

Figure 22B

select SOURCE INPUT from the On-Screen Menu, followed by pressing the Left◀ or Right▶ directional push-buttons to select the TV Input, Number 7. Using the Up▲ or Down▼ directional push-buttons, select HDMI VIDEO on the On-Screen Menu, followed by pressing the Left◀ or Right▶ directional push-buttons to select NONE.

31. Using the Up▲ or Down▼ directional push-buttons, select SOURCE INPUT from on the On-Screen Menu, followed by pressing the Left◀ or Right▶ directional push-buttons to select CD2 Input 3. Refer to figure 22A.
32. Using the Up▲ or Down▼ directional push-buttons, select HDMI VIDEO from the On-Screen Menu, followed by pressing the Left◀ or Right▶ directional push-buttons to select the Number 2.
33. If you do not wish to perform COMPONENT VIDEO Adjustments at this time, proceed to How to Change the Volume Setup on page 38.

### Component Video Input

The MX136 has Electronic Input Switching for five Component Video Sources and they may be assigned to any of the eleven Analog Audio/Digital Inputs. The following example describes how to reassign COMPONENT 4 IN Video Input, which by default has been assigned to VCR2 Input, over to the newly created DVD2 Input and switching the VCR2 Component Video Input to Off.

*Note: The MX136 allows for assigning a Component Video Input to multiple Analog Audio/Digital Inputs.*

34. Using the Up▲ or Down▼ directional push-buttons, select SOURCE INPUT from the On-Screen Menu, followed by pressing the Left◀ or Right▶ directional push-buttons to select the DVD2 Input, Number 5.
35. Using the Up▲ or Down▼ directional push-buttons,

select COMPONENT VIDEO on the On-Screen Menu, followed by pressing the Left◀ or Right▶ directional push-buttons to select 4. Refer to figure 22B.

36. If the DVD2 Input is to be viewed through the HDMI Monitor A Output, use the Up▲ or Down▼ directional push-buttons, select HDMI VIDEO on the On-Screen Menu, followed by pressing the Left◀ or Right▶ directional push-buttons to select COMP. Refer to figure 22C.
37. Using the Up▲ or Down▼ directional push-buttons, select SOURCE INPUT from the On-Screen Menu, followed by pressing the Left◀ or Right▶ directional push-buttons to select the VCR2 Input, Number 10.
38. Using the Up▲ or Down▼ directional push-buttons, select COMPONENT VIDEO on the On-Screen Menu, followed by pressing the Left◀ or Right▶ directional push-buttons to select OFF.

The MX136 Video Converter feature allows the Up-Conversions of Composite Video Signals to S-Video and Component Video; S-Video Input Signals may be converted to Component Video. This will provide better picture quality and will simplify video connections and operation of the TV/Monitor. In the following example, the LV Input 8 has a S-Video Signal and it will be converted to Component Video. It will also be made available through the HDMI Monitor A Output.

39. Using the Up▲ or Down▼ directional push-buttons, select SOURCE INPUT from the On-Screen Menu, followed by pressing the Left◀ or Right▶ directional push-buttons to select the LV Input, Number 8.
40. Using the Up▲ or Down▼ directional push-buttons, select COMPONENT VIDEO on the On-Screen

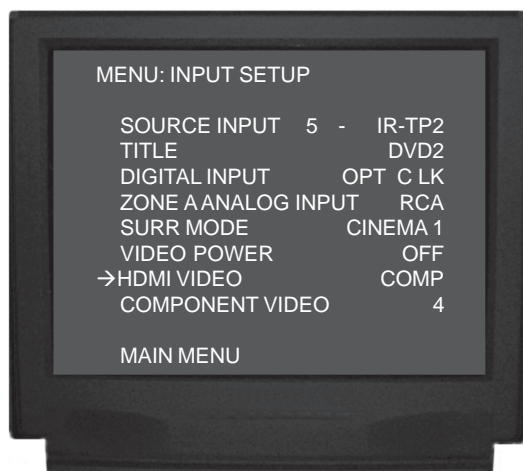

Figure 22C

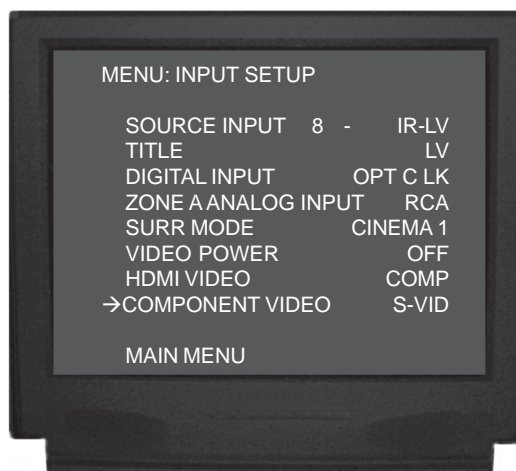

Figure 23

Menu, followed by pressing the Left◀ or Right▶ directional push-buttons to select S-VID. Use the Up▲ or Down▼ directional push-buttons to select HDMI VIDEO on the On-Screen Menu, followed by pressing the Left◀ or Right▶ directional push-buttons to select COMP Refer to figure 23.

41. Using the Up▲ or Down▼ directional push-buttons, select MAIN MENU on the On-Screen Menu and press the SELECT/OK Push-button.
42. Continue next to the VOLUME SETUP on page 38. If you do not wish to perform VOLUME SETUP Adjustments at this time, select MAIN MENU from the menu. The MAIN SYSTEM SETUP Menu will reappear on the Monitor/TV screen and proceed to the next step.
43. Select EXIT from the MAIN SYSTEM SETUP Menu. If you are satisfied with the changes that you may have made, select YES to save those changes or NO not to save them. The MX136 will then return to normal

operation. Refer to figure 7 on page 27.

Analog and Digital Audio Input Source Settings				
Number	Default Title	New Title	Digital Input	
			Default Input	New Input
0	TUNER		-	
1	PH/AUX		-	
2	CD1		A-Optical	
3	CD2		D-Coaxial	
4	TAPE1		-	
5	TAPE2		-	
6	SAT		B-Optical	
7	TV		E-Coaxial	
8	LV		C-Optical	
9	VCR1		-	
10	VCR2		-	
11	DVD		F-Coaxial	

Video Inputs Source Settings							
Number	Title	Video Power Control		Component Video Source		HDMI Video Source	
		Default Setting	New Setting	Default Setting	New Setting	Default Setting	New Setting
0	TUNER	ON		-		-	
1	PH/AUX	ON		-		-	
2	CD1	ON		-		-	
3	CD2	ON		-		-	
4	TAPE1	ON		-		-	
5	TAPE2	ON		-		-	
6	SAT	ON		1		1	
7	TV	ON		2		2	
8	LV	ON		-		-	
9	VCR1	ON		3		3	
10	VCR2	ON		4		-	
11	DVD	ON		5		4	

## How to Change the Volume Setup

The MX136 has provisions for setting the wake-up volume listening level for Zones A and B. A maximum volume listening level can also be set for both zones.

1. Press and hold the Front Panel SETUP Push-button approximately three seconds to enter the Setup Mode. The word SETUP will appear on the MX136 Front Panel Display and the MAIN SYSTEM SETUP Menu will appear on the Monitor/TV screen. Refer to figure 6 on page 26.
2. Using the Up▲ or Down▼ directional push-buttons on the Remote Control, select VOLUME SETUP on the On-Screen Menu, followed by the SELECT/OK Push-button. Refer to figure 24.
3. Using the Up▲ or Down▼ directional push-buttons, select ZONE A VOLUME PRESET from the On-Screen Menu, followed by pressing the Left◀ or Right▶ directional push-buttons to select either LAST (the last volume level listened to) or a fixed (0-99) wake-up volume level. Refer to figure 25.

*Note: The Remote Control Volume Up▲ and Down▼ push-buttons may also be used.*

4. Using the Up▲ or Down▼ directional push-buttons, select ZONE A VOLUME MAXIMUM from the On-Screen Menu, followed by pressing the Left◀ or Right▶ directional push-buttons to select the maximum volume level.
5. If desired, make similar adjustments for Zone B.
6. Continue to the ADVANCED settings on page 39. If you do not wish to perform ADVANCED settings at this time, select MAIN MENU from the menu. The MAIN SYSTEM SETUP Menu will reappear on the Monitor/TV screen and proceed to the next step.
7. Select EXIT from the MAIN SYSTEM SETUP Menu. If you are satisfied with the changes that you may have made, select YES to save those changes or NO not to save them. The MX136 will then return to normal operation. Refer to figure 7 on page 27.



Figure 24

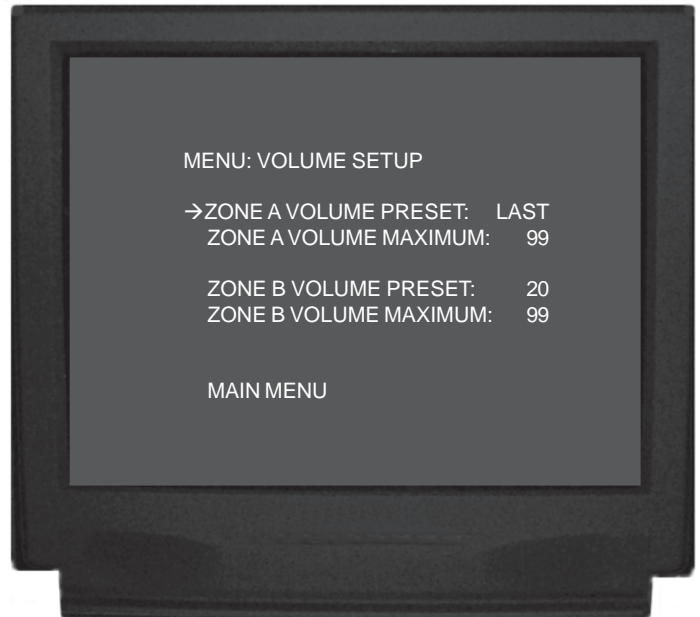

Figure 25

Zone Volume Levels		
Zone	Default Setting	New Setting
Zone A Wake-Up	Last	
Zone A Maximum	99	
Zone B Wake-Up	20	
Zone B Maximum	99	

## How to change the Advanced Settings

1. Press and hold the Front Panel SETUP Push-button approximately three seconds to enter the Setup Mode. The word SETUP will appear on the MX136 Front Panel Display and the MAIN SYSTEM SETUP Menu will appear on the Monitor/TV screen. Refer to figure 6 on page 26.
2. Using the Up▲ or Down▼ directional push-buttons on the Remote Control, select ADVANCED on the On-Screen Menu, followed by the SELECT/OK Push-button. Refer to figure 26.



Figure 26

### HDMI Output Format

The MX136 incorporates HDMI Switching with upscaling for 480i/576i Component Video Signals to either 480p, 720p or 1080i output. The default setting of Auto will work with most systems, however if a change is needed perform the following:

3. Using the Up▲ or Down▼ directional push-buttons, select HDMI OUTPUT FORMAT from the On-Screen Menu. Refer to figure 26.

4. Use the Left◀ or Right▶ directional push-buttons to Select 480i, 480p, 720p or 1080i.

HDMI Switching and Scaling	
Input Signal Type	Output Scaling
Composite 480i/576i	Straight through
S-Video 480i/576i	Straight through
Component Video 480i/576i	480p, 720p or 1080i
Component Video 480p/576p	480p, 720p or 1080i
Component Video 720p	Straight through
Component Video 1080i	Straight through
HDMI Digital Signal	Straight through

### RC Input Toggle

The MX136 incorporates Automatic Digital/Analog Audio Input Switching. When a source with an assigned digital input is selected, the MX136 will automatically search first for a Digital Audio Signal; if no Digital Signal is sensed, it switches to the Analog Signal. This RC Input Toggle feature can be manually overridden at any time by simply re-selecting that same source by pressing the appropriate Remote Control Push-button. To activate the RC Input Toggle perform the following steps:

5. Using the Up▲ or Down▼ directional push-buttons, select DIGITAL SETTINGS from the On-Screen Menu, followed by the SELECT/OK Push-button.
6. Use the Left◀ or Right▶ directional push-buttons to Select ON. Refer to figure 27.
7. Using the Up▲ or Down▼ directional push-buttons, select ADVANCED MENU from the On-Screen Menu,

8. Continue to the INPUT SELECT POWER ON Setting. If you do not wish to perform INPUT SELECT POWER ON Setting at this time, select the MAIN MENU. The MAIN SYSTEM SETUP Menu will reappear on the Monitor/TV screen and proceed to the next step.
9. Select EXIT from the MAIN SYSTEM SETUP Menu. If you are satisfied with the changes that you may have made, select YES to save those changes or NO not to save them. The MX136 will then return to normal operation. Refer to figure 7 on page 27.

### Input Select Power On

The MX136 has a feature called Input Select Power On that allows for easier operation. When an Input Source Push-button on the Remote Control or Keypad is pressed, the MX136 will automatically switch-on without first having to press the STANDBY/ON Push-button. This feature may be de-activated by performing the following. Refer to figure 28 on the next page.



Figure 27

10. Using the Up▲ or Down▼ directional push-buttons, select INPUT SELECT POWER ON from the On-Screen Menu, followed by pressing the Left◀ or Right▶ directional push-buttons to select OFF.
11. Using the Up▲ or Down▼ directional push-buttons, select the MAIN MENU. The MAIN SYSTEM SETUP Menu will reappear on the Monitor/TV screen and proceed to the next step.
12. Select EXIT from the MAIN SYSTEM SETUP Menu. If you are satisfied with the changes that you may have made, select YES to save those changes or NO not to save them. The MX136 will then return to normal operation. Refer to figure 7 on page 27.

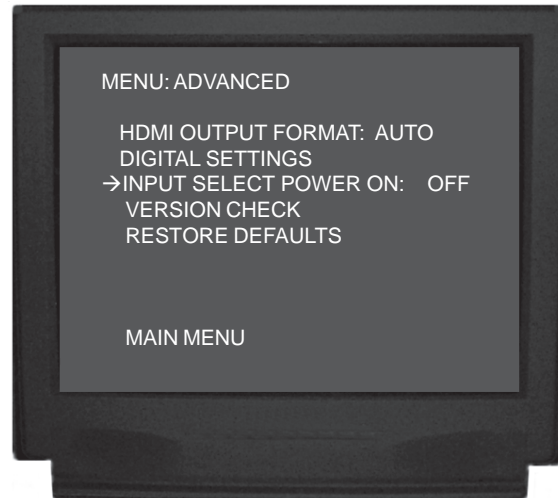

Figure 28

### Version Check

McIntosh makes different versions of the MX136 to meet the requirements in each country where it is sold. The MX136 can display that version information by the following steps.

13. Using the Up▲ or Down▼ directional push-buttons, select VERSION CHECK from the On-Screen Menu, followed by pressing the SELECT/OK Push-button.
 

```

            MX-136 V _ . . . _
            DAE - _ _ _ _ V _ . . .
            NTSC VIDEO
            USA TUNER
            RS232 OFF
            
```

*Note: The MX136 RS232 Port Connection is controllable when connected to an external computer with the appropriate software.*
14. Press the SELECT/OK Push-button to return to the ADVANCED Menu.
15. Select the MAIN MENU. The MAIN SYSTEM SETUP Menu will reappear on the Monitor/TV screen and proceed to the next step.
16. Select EXIT from the MAIN SYSTEM SETUP Menu. If you are satisfied with the changes that you may have made, select YES to save those changes or NO not to save them. The MX136 will then return to normal operation. Refer to figure 7 on page 27.

### Restore Defaults

The MX136 permits returning all of the previously entered On-Screen Operating Settings back to the Factory Default Values by the following steps.

*Note: It is advisable to write down all current settings before proceeding, in the event you desire to re-enter them later.*

17. Using the Up▲ or Down▼ directional push-buttons, select RESTORE DEFAULTS from the On-Screen Menu, followed by pressing the SELECT/OK Push-button.
18. Using the Up▲ or Down▼ directional push-buttons,

- select YES from the On-Screen Menu, followed by pressing the SELECT/OK Push-button. Refer to figure 29.
19. The On-Screen Menu will give you a second chance before the MX136 will be returned to the Factory Default Settings. Using the Up▲ or Down▼ directional push-buttons, select YES from the On-Screen Menu, followed by pressing the SELECT/OK Push-button.
20. Select the MAIN MENU. The MAIN SYSTEM SETUP Menu will reappear on the Monitor/TV screen, proceed to the next step.
21. Select EXIT from the MAIN SYSTEM SETUP Menu. If you are satisfied with the changes that you may have made, select YES to save those changes or NO not to save them. The MX136 will then return to normal operation. Refer to figure 7 on page 27.
22. Switch the Main POWER Switch to the OFF Position.
23. Wait two minutes, then place the Main POWER Switch to the ON Position, then press the STANDBY Push-button.

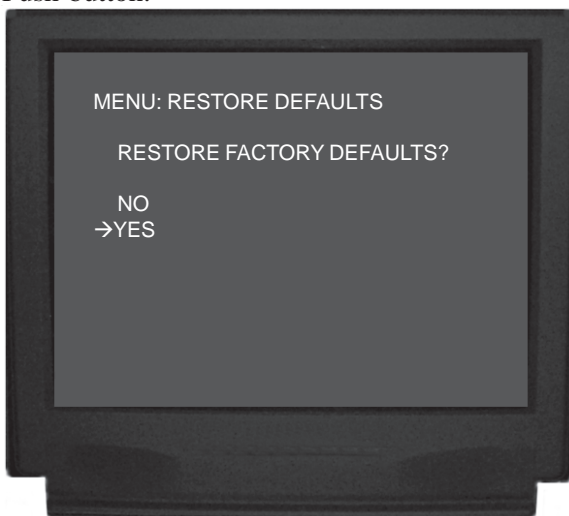

Figure 29



## How to Operate the MX136

The McIntosh MX136 has been factory configured for default operating settings that will allow immediate enjoyment of superb video and high fidelity audio without the need for further adjustments. If you wish to make changes to the factory default settings refer to the SETUP Section of this Owner's Manual.

### Power On and Off

Press the POWER switch to ON, the Red Indicator above the STANDBY/ON Push-button lights to indicate the MX136 is in Standby Mode and the title MX-136 will appear on the Front Panel Alphanumeric Display for approximately two seconds. To Switch-On the MX136 press the STANDBY/ON Push-button. During the circuitry initialization period (approximately four seconds) after turn-on, the Front Panel Alphanumeric Display will first indicate the word MUTE (Audio Outputs will be muted). Refer to figures 30 and 31.



Figure 30



Figure 31

*Note: For normal operation, turn the MX136 On and Off with the Standby/On Push-button. You may also turn On the MX136 by simply pressing the ON Push-button on the Remote Control. If the A/V System Controller is not going to be used for an extended period of time,*

*turn Off all AC Power with the Power Switch. If the MX136 is in the Standby Mode and is connected to a McIntosh Audio/Video Multizone Control System Controller, the Front Panel Alphanumeric Display will indicate REMOTE ZONE when any Zone of the Controller is switched On.*

### Input Selection

The INPUT A Selector Switch selects the program signal source for Zone A and is indicated on the right side of the Front Panel Alphanumeric Display. The INPUT B Selector Switch selects the program signal source for Zone B and the VCR outputs with the selected source indicated on the left side of the Front Panel Alphanumeric Display. Refer to figure 32. The Selection of the source inputs for Zone A may also be accomplished by pressing the appropriate push-button on the Remote Control.

*Note: If the "RC Digital Toggle" feature in setup has been set to On, an additional press of the source selection push-button on the Remote Control will allow selection of either the Digital or Analog Signal Source for that assigned input. Refer to page 39 for additional information.*

### Volume Control

Adjust the VOLUME Control to select the desired level in Zone A (Listen). The Volume Control adjusts all eight channels simultaneously, and level is indicated from 0 to 99 in the center of the front panel display. Zone B is not affected by the front panel VOLUME Control. Zone B (Record) volume level is adjusted only in Zone B with a Remote Control or Keypad.



Figure 32



### System Off

Normally, Remote Zones are turned On and Off individually in each respective zone by pressing the Power Push-button on a Keypad or Remote Control. If you desire to switch Off all zones of an entire McIntosh System simultaneously, including a Control Center and accessory source components, you can press the SYS OFF Push-button on the MX136 Front Panel. Refer to figure 33.

*Note: The Sys Off Push-button on a Keypad or Remote Control may also be used to switch Off the entire system.*

### Setup

Pressing the SETUP Push-button for three seconds activates the MX136 SETUP Mode for making changes to the Home Theater System.

### Tuning ▼▲

The TUNING Up▲ and Down▼ Push-buttons allow for tuning up and down the FM or AM Radio Bands when the optional TM1 Tuner Module is installed.

### Select

When the MX136 has the optional TM1 Tuner Module installed, the SELECT Push-button allows for selecting either the FM or AM Broadcast Bands.

### Enter

When the MX136 has the optional TM1 Tuner Module installed, the ENTER Push-button is used for entering AM or FM Broadcast Stations into memory.

### Preset ◀ ▶

The PRESET Left◀ and Right▶ Push-buttons allow for selecting the next FM or AM Radio Station that has been stored into memory, when the optional TM1 Tuner Module is installed.

### Late Night

The LATE NIGHT Push-button turns a volume compression circuit On and Off. This feature suppresses loud sounds or music that might disturb neighbors or others not in the immediate area of the Home Theater. Soft levels are also raised slightly so they are still listenable at reduced overall volume levels. This works only on a Dolby Digital Sound Track with encoded data that supports the compression function.

### Reset of Microprocessors

In the event that the controls of the MX136 stop functioning, there is a built-in user reset function. Press the POWER Switch to OFF and wait for two minutes. Then Press the POWER Switch to ON. This will reset the MX136 microprocessors. Refer to figure 32 on page 41.

*Note: The above condition is usually caused by either interruptions in AC power and/or major changes in voltage.*

### Front Panel Status

The three sets of front panel LEDs indicate the status of Input Format, Operating/Decoding Modes and the Output Format. Refer to figure 33.

*Note: If a Digital Input is selected and the Digital Source Component is not producing an output signal, none of the Front Panel Status LEDs will illuminate.*



Figure 33

Input Format

A. If the input signal source is Eight Channel Discrete, the front panel INPUT FORMAT LEDs L, C, R, LS, LFE, RS and S will illuminate. Refer to figure 34.

B. If a Digital Input Signal Source is 2 Channel Surround Encoded, the front panel INPUT FORMAT LEDs L, R and S will illuminate.

*Note: This will only occur when the SURROUND MODE is in CINEMA1 or CINEMA2.*

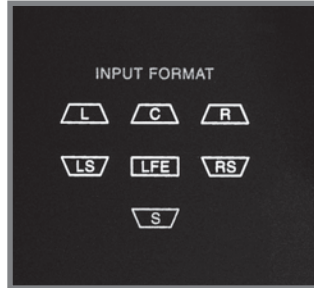

Figure 34

C. If the Analog Input Signal Source is Stereo, the INPUT FORMAT LEDs L and R will illuminate.

D. If an Analog Input Signal Source is Mono, both channels will be receiving the mono signal and the INPUT FORMAT LEDs L and R will illuminate.

Operating Mode Displays

E. The DOLBY DIGITAL Display will illuminate when the input contains Dolby Digital Encoded Signals. Refer to figure 35.

F. The EX (Dolby Digital) Display will illuminate when the input contains Dolby Digital EX Encoded Signals.

G. The PRO LOGIC IIx Display will illuminate when the Surround Mode Selector is turned to CINEMA1 or MUSIC 1 positions.

H. The DIGITAL SIGNAL Display will illuminate when the MX136 is processing a Digital Encoded Signal.

I. The DTS Display will illuminate when the input contains DTS Encoded Signals.

J. The DTS ES Display will illuminate when the input contains DTS ES Encoded Signals.

K. The NEO:6 Display will illuminate when the Surround Mode Selector is turned to CINEMA2 or MUSIC 2 positions.

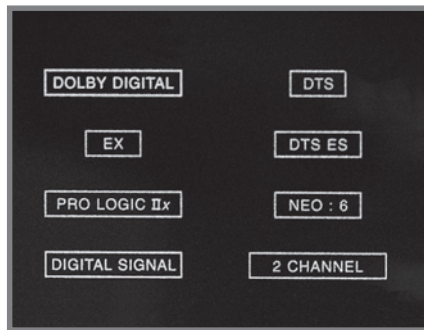

Figure 35

L. The 2 CHANNEL Display will illuminate when the Surround Mode Selector is turned to STEREO (2 CHANNEL) positions.

Output Format:

M. The OUTPUT FORMAT LEDs indicate the SURROUND MODE selected and the active audio channels. Refer to figure 36.

*Note: The following example of the illuminated LED is based upon a 7.1 channel system. If your system is configured as something other than 7.1 (e.g. no Center Loudspeaker or a single BackSurround Loudspeaker) then the number of LEDs illuminated will be different.*

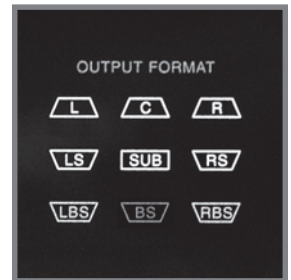

Figure 36

N. STEREO mode will cause the L, R and SUB LEDs to illuminate.

O. MUSIC 1, 2, 3, and 4 modes will cause the L, C, R, LS, SUB, RS, LBS and RBS to illuminate.

P. CINEMA1 mode will cause the L, C, R, LS, SUB, RS, LBS and RBS to illuminate.

Q. CINEMA2 mode will cause the L, C, R, LS, SUB, RS, LBS and RBS to illuminate.

R. EXTERNAL mode will cause the L, C, R, LS, SUB, RS, LBS and RBS to illuminate.



## How to Operate the Trim Mode

The MX136 TRIM SELECT Switch together with the TRIM LEVEL Control provide the means for adjusting seven different audio functions and the Front Panel Alphanumeric Display Brightness. This can be accomplished from either the Front Panel Controls or with the supplied Remote Control, very conveniently from the Listening/Viewing Area. The Front Panel Alphanumeric Display indicates the Trim Mode Selected and Trim Levels. You can create the sound quality that you prefer while listening to music or a movie sound track. Refer to figures 37 & 39.

*Note: The following Trim Examples are performed using the MX136 Front Panel Controls. They also can be made using the supplied Remote Control. Make any Trim Adjustments based on your own preferences.*

### Loudspeaker Volume Levels

The Volume Levels of the Center, Subwoofer and Surround Loudspeakers can be adjusted up or down by 12dB relative to the Left and Right Front Loudspeakers and saved in permanent memory for the Stereo, Music (1 - 4) and External Surround Modes. They are automatically recalled any time that particular input is selected again. The Surround Trim level adjustments made in CINEMA 1 and CINEMA 2 will revert back to the Setup Loudspeaker Levels when the MX136 is placed in STANDBY (Off).

1. Rotate the TRIM SELECT Control to the SUBWOOFER position and SUB TRIM appears on the Front Panel Alphanumeric Display. Refer to figure 37.

*Note: Low Frequency Information must be present in the Program Source Material in order to hear any changes in the Subwoofer Loudspeaker Levels.*



Figure 37

2. Rotate the TRIM LEVEL Control clockwise until the number 5 appears to the right of SUB TRIM on the Front Panel Alphanumeric Display. This is an example of increasing the Subwoofer level by 5dB.
3. Rotate the TRIM SELECT Control to the SURR SPKR position and SURR TRIM appears on the Front Panel Alphanumeric Display. Refer to figure 38.



Figure 38

4. Rotate the TRIM LEVEL Control counter-clockwise until the number -10 appears to the right of SURR TRIM on the display. This is an example of decreasing the Surround Loudspeakers Levels by 10dB.

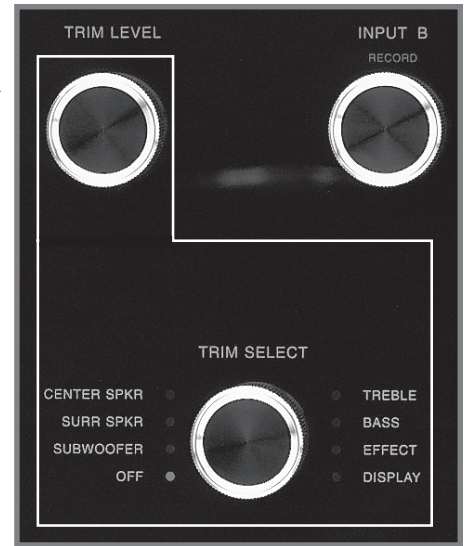

Figure 39

5. Rotate the TRIM SELECT Control to the CENTER SPKR position and CTR TRIM appears on the Front Panel Alphanumeric Display. Refer to figure 40.



Figure 40

6. Rotate the TRIM LEVEL Control clockwise until the number 3 appears to the right of CTR TRIM on the Front Panel Alphanumeric Display. This is an example of increasing the Center Loudspeaker Level by 3dB.

*Notes: 1. If no Trim adjustments are made during a ten second interval, the TRIM Mode will be cancelled and the normal Front Panel Display will appear.*

2. The location of the Trim Selector Control will remain in the last selected position until the INPUT A Listen Control or SURROUND MODE Control is changed.

### Bass and Treble

The MX136 allows for changing the tonal response for any of the eleven inputs via the BASS and TREBLE Compensation TRIM Adjustments. Any tonal changes made are saved in permanent memory and automatically recalled any time that particular input is selected again. The Bass and Treble Tonal Response can be adjusted up or down by 12db from the Flat Setting.

1. Rotate the TRIM SELECT Control clockwise until BASS TRIM appears on the Front Panel Alphanumeric Display. Refer to figure 41.



Figure 41

2. Rotate the TRIM LEVEL Control clockwise until the number 10 appears to the right of BASS TRIM on the Front Panel Alphanumeric Display. This is an example of increasing the Bass response by 10dB.
3. Rotate the TRIM SELECT Control clockwise until TREB TRIM appears on the Front Panel Alphanumeric Display. Refer to figure 42.



Figure 42

4. Rotate the TRIM LEVEL Control clockwise until the number 11 appears to the right of TREB on the Front Panel Alphanumeric Display. This is an example of increasing the Treble response by 11dB.

### Effects

The MX136's Trim Select Effect Mode allows for different types of audio signal processing as different Surround Modes are selected. Refer to the chart below:

Trim Effect Mode	
Surround Mode	Effect Sound Type
Stereo	Loudness Compensation
Cinema 1	Loudness Compensation
Cinema 2	Loudness Compensation
External	Loudness Compensation
Music 1*	Center Width
Music 2**	Center Width
Music 4	Sound Stage Variations
*when a two channel signal is processed in the Dolby Pro Logic IIx Mode	
**when a two channel signal is processed in the DTS NEO:6 Mode	

If the STEREO MODE, CINEMA 1 or 2, or EXTERNAL Surround Modes are selected the Trim Select Effect Mode provides variable Loudness Compensation.

When the MUSIC 1 Surround Mode is selected and a two channel audio signal is processed in the Dolby Pro Logic IIx Mode, the Trim Select Effect Mode provides variable Center Channel Width Adjustment. Likewise, with the MUSIC 2 Surround Mode selected and a two channel audio signal is processed in the DTS NEO:6 Mode, the Trim Select Effect Mode also provides variable Center Channel Width Adjustment.

If MUSIC 3 or 4 Surround Modes are selected the Trim Select Effect Mode provides variable Reverberation of the sound going to the Surround Loudspeakers.

### Loudness

The Loudness Control Function automatically increases bass response as the volume level is lowered for improved listening at softer volume levels. The amount of Loudness Boost is adjustable in 10% increments from 10% to 100%. The maximum Loudness boost is 18dB, less any bass boost that may have been previously set by the Bass Trim function. For example if the Bass is boosted 10dB, the maximum additional Loudness boost will be 18dB less 10dB or 8dB. Refer to figure 43.

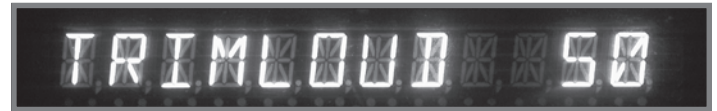

Figure 43

1. Rotate the TRIM SELECT Control clockwise to the EFFECT position. The word TRIMLOUD will appear on the Front Panel Alphanumeric Display.
2. Rotate the TRIM LEVEL Control clockwise until the desired percent of Loudness is indicated to the right of TRIMLOUD on the Front Panel Alphanumeric Display.

## Center Width

This mode takes some of the Center Channel Signal and adds it to the Left and Right Front Loudspeakers, thus increasing the width of the front sound field. The effect can be varied with eight different settings ranging from minimum (0) to maximum (7). Refer to figures 44 and 45.

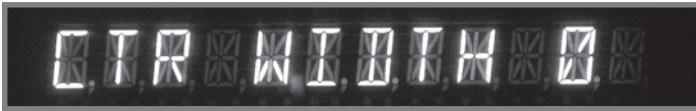

Figure 44

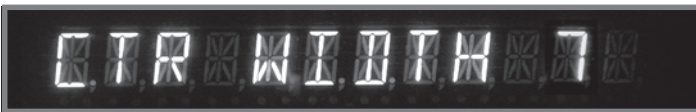

Figure 45

3. Rotate the TRIM SELECT Control clockwise to the EFFECT position. The words CTR WIDTH will appear on the Front Panel Alphanumeric Display.
4. Rotate the TRIM LEVEL Control clockwise until the desired sound stage is achieved.

## Effect

When the MUSIC 4 Surround Mode is selected, the EFFECT Mode allows for various alterations to the Front Sound Stage via the Surround Loudspeakers.

5. Rotate the TRIM SELECT Control clockwise to the EFFECT position. The word EFFECT together with a number will appear on the Front Panel Alphanumeric Display. Refer to figure 46.



Figure 46

6. Rotate the TRIM LEVEL Control to select one of the many different sound effects available.

## Display Brightness

The brightness of the Front Panel Alphanumeric Display may be adjusted using the Display Trim Feature. The Display brightness range extends from Off to a maximum brightness setting of 31.

1. Rotate the TRIM SELECT Control clockwise until DISPLAY appears on the Front Panel Alphanumeric Display. A number to the right of the display indicates the current brightness level. Refer to figure 47.
2. Rotate the TRIM LEVEL Control until the desired display brightness is achieved.



Figure 47

## How to Operate the Surround Mode

The MX136 provides nine different Surround Modes. The Front Panel Alphanumeric Display and the Output Format LEDs will indicate the Surround Mode selected. The Surround Mode Selected is stored into permanent memory and automatically recalled any time that particular input is selected again. If the Surround Mode is changed when the input is again selected, the new mode will be active and stored. Refer to figure 48.

*Note: The*

*Remote Control may also be used to make changes to the Surround Modes.*



Figure 48

### Stereo Mode

A Stereo signal source connected to an Analog Audio Input is reproduced without any processing. The Front Panel Alphanumeric Display will indicate PURE STEREO. When a Digital Audio Input is selected in Stereo Mode, the Front Panel Alphanumeric Display will indicate DSP STEREO. All multichannel signal sources are combined and reduced to 2 channels in the stereo mode. Refer to figures 49 and 50.



Figure 49



Figure 50

### Music 1

The Front Panel Alphanumeric Display will indicate MUSIC 1. Refer to figure 51. This Mode utilizes Dolby Pro Logic II Processing to create a wide and deep sound space. The effect may be varied depending upon the Trim Effect Setting for “Center Width”, refer to page 46 to alter the settings.



Figure 51

### Music 2

The Front Panel Alphanumeric Display will indicate MUSIC 2. Refer to figure 52. This Mode utilizes DTS NEO:6 Processing to add center, surround and back channels to a stereo recording. The effect may be varied depending upon the Trim Effect Setting for “Center Width”, refer to page 46 to alter the settings.



Figure 52

### Music 3

The Front Panel Alphanumeric Display will indicate MUSIC 3. Refer to figure 53. This processing Mode creates an effect of a party in a small room. A Center Channel and Back Surround Channel are created from the sum of the Left and Right Front Channels. The Left and Right Front Channel Information is also sent to the Surround Loudspeakers.

*Note: The Music 3 Surround Mode is intended for use with two channels of audio information.*



Figure 53

### Music 4

The Front Panel Alphanumeric Display will indicate MUSIC 4. Refer to figure 54. This processing Mode creates an effect of a Night Club. A Center Channel is created from the Left and Right Front Channels. The Left and Right Front Channels are processed through the Trim Effect and sent to the Surround Loudspeakers. Refer to page 46 to alter the Trim Effect settings.

*Note: The Music 4 Surround Mode is intended for use with two channels of audio information.*



Figure 54

### Cinema 1

The Front Panel Alphanumeric Display will indicate CINEMA 1 and the appropriate Front Panel Operating Mode Display LEDs will illuminate. Refer to figure 55 on page 48. This provides Dolby Pro Logic IIx processing of Analog Signals and 2-Channel Digital Signals.

When a Dolby Digital or DTS Signal is present the MX136 will automatically decode the information either as Mono, Stereo, Surround or 5.1 discrete depending on the information contained in the signal. If a 5.1 signal contains back surround information (Dolby Digital EX or DTS ES/EX), the decoder will reproduce all 7.1 channels of information.



Figure 55

**Cinema 2**

The Front Panel Alphanumeric Display will indicate CINEMA 2 and the appropriate Front Panel Operating Mode Display LEDs will illuminate. Refer to figure 56. This provides DTS NEO:6 processing Analog Signals and 2-Channel Digital Signals.

When a Dolby Digital or DTS Digital Signal is present the MX136 will automatically decode the information either as Mono, Stereo or Surround depending on the information contained in the signal. If the signal contains 5.1 or more channels of information, the decoder will automatically reproduce the signal as 7.1 channels of information.



Figure 56

**External**

All internal signal processing is bypassed and the eight Rear Panel EXTERNAL INPUTS are activated so the MX136 performs as an Eight Channel Preamplifier for an external source or processor. The Front Panel Alphanumeric Display indicates EXTERNAL. Refer to figure 57.



Figure 57

*Note: Approximately 3 seconds after selecting EXTERNAL SURROUND MODE, the Front Panel Alphanumeric Display will change, indicating EXTERNAL, to the normal display of INPUT A, INPUT B and percentage of VOLUME.*

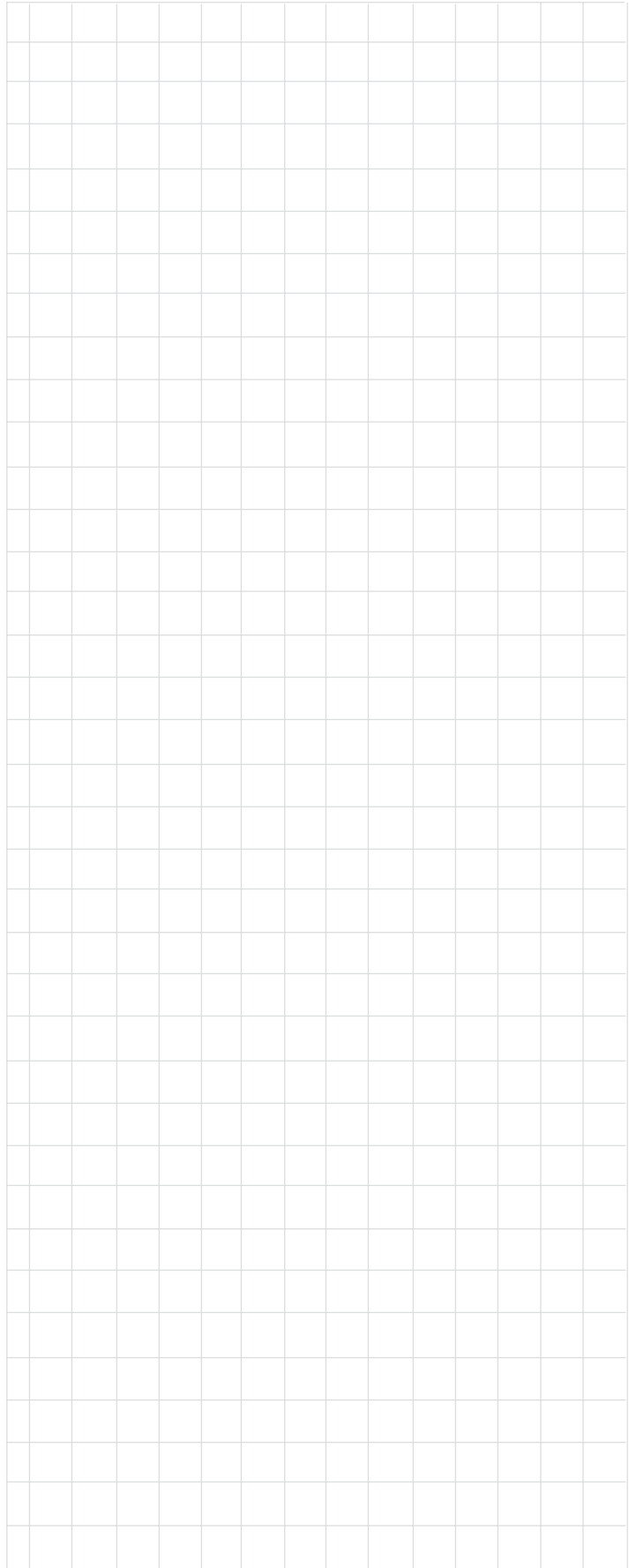



## How To Make A Recording

### Analog Audio Recording

The separate INPUT B (Record) and INPUT A (Listen) Switches allow for the making of an Analog Audio Recording from one program source while listening to another. This allows for the listening (monitor) to the recorded signal off the tape, a fraction of a second later, during recording when a three head tape recorder is used. Refer to figure 58.

1. Select the desired Analog Audio Program Source to record with the Front Panel INPUT B RECORD Control.
2. Adjust the record level using the Recorder Volume Control.
3. To listen to the signal going to the recorder from the MX136, rotate the front panel INPUT A LISTEN Control to the same input as selected with the INPUT B RECORD Control.
4. To listen to the tape playback of the program source just recorded, rotate the INPUT A LISTEN Control to select the Record/Play device.

*Note: The MX136 record OUTPUTS are not affected by the VOLUME, SURROUND or TRIM controls. To listen to a different program source while recording, rotate the INPUT A LISTEN Control to the desired source. The recording process will not be affected and will continue.*

### Digital Audio Recording

The MX136 allows recording from any of the Digital Audio Input Sources to an external Digital Recording Device. Refer to figure 58.

*Note: If an Optical Input Source is selected the digital signal will be available at both Optical and Coaxial Digital Outputs. Likewise the same will occur if a Coaxial Input Source is selected, the Digital Signal will be available at both Digital Outputs.*

1. Select the desired Digital Audio Program Source to record with the Front Panel INPUT A LISTEN Control.
2. Adjust the record level using the Recorder Volume Control, if present.
3. To listen to the playback of the Digital Program Source just recorded, rotate the INPUT A LISTEN Control to select the Record/Play device.

*Note: The MX136 DIGITAL OUTPUTS are not affected by the VOLUME, SURROUND or TRIM controls.*



Figure 58

## How to Operate Zone B

The MX136 includes the capability of being able to operate and control two audio/video zones, independently of each other. Zone A is the Primary (Home Theater Listening Area) with Surround Sound. Zone B is configured for a Secondary Remote Location providing two channel audio and video programs.

The MX136 Front Panel Alphanumeric Display indicates the Zone A Program Source Selected on the right side and the Zone B Program Source Selected on the left side. Refer to figure 58 on page 49.

### Operating Zone B from the MX136 Front Panel

To activate Zone B Control from the MX136 Front Panel, perform the following steps.

1. Press the Front Panel STANDBY/ON Push-button, if Zone A is not active.
2. Press the ZONE B Push-button and immediately press the STANDBY/ON Push-button, the Front Panel Alphanumeric Display will indicate Zone B Input Source Select and Volume Level. Refer to figure 59.

*Note: During the time the LED Indicator above the ZONE B Push-button is illuminated (approximately three seconds), the Zone B Volume Level may be changed using the VOLUME Control. The Zone B Power may also be switched Off by pressing the Front Panel STANDBY/ON Push-button within the three second time period. If the Front Panel Control reverts back to Zone A (the LED Indicator above the ZONE B Push-button is not illuminated), press the ZONE B Push-button again to activate control of Zone B.*



Figure 59

3. Rotate the INPUT B (Record) Selector Switch to select the desired source.
4. Press the ZONE B Push-button and then rotate the VOLUME Control to the desired volume level for Zone B.
5. To switch Off Zone B from the MX136 Front Panel if Zone A is already Off, press the SYS OFF Push-button. Refer to figure 60.



Figure 60

### Operating Zone B from a Keypad or Sensor

To activate Zone B Control from the Keypad or Sensor perform the following steps. Refer to figure 61.

1. Press the POWER Push-button on the Keypad or use the Remote Control aimed at a Sensor located in Zone B.

*Note: When Zone B is switched On the MX136 Front Panel*



Figure 61

*Alphanumeric Display will indicate ZONE B ON, if Zone A is not active.*

2. Select the desired Zone B Source and adjust the Volume to the desired listening level by pressing the appropriate push-buttons on the Keypad or Remote Control.
3. If a McIntosh Disc Player is connected to the MX136, most operating functions can be performed with the Keypad or Remote Control.

*Note: By adding a McIntosh Remote Control Translator to the MX136, non McIntosh Source Devices, such as a Satellite Receiver, can be remotely controlled using a McIntosh Remote Control and Keypads.*

### Controlling a Source Component from Zone B

To control a source component from the Keypad or Sensor perform the following steps. Refer to figure 61.

1. Press the appropriate source push-button (e.g. CD) on the Keypad or Remote Control. Then press the appropriate control push-button for the desired function (e.g. the Next ►► Push-button to play the next selection from the disc).

### Audio Specifications

#### Frequency Response

Left, Center, Right,  
Left Surround,  
Right Surround,  
Left Back, Right Back:  
±0.5dB from 20Hz-20,000Hz

#### Subwoofer<sup>1</sup>:

±0.5dB from 20Hz-140Hz

#### Total Harmonic Distortion

0.005% maximum from 20Hz to 20,000Hz at rated output

#### Signal To Noise Ratio

Phono: 86dB below 10mV input (A Weighted)  
High Level: 96dB below rated output (A Weighted)

#### Rated Output Voltage

2.5V Unbalanced Outputs (Main)  
5.0V Balanced Outputs (Main)

#### Maximum Voltage Output

9.5V Unbalanced  
19V Balanced

#### Output Impedance

100 ohms Unbalanced  
200 ohms Balanced

#### Input Impedance

Phono: 47k Ohms, 65pf  
High Level: 22k Ohms Unbalanced  
50k Ohms Balanced

#### Sensitivity for Rated Output

Phono: 5mV  
High Level: 500mV Unbalanced  
1V Balanced

#### Maximum Input Signal

Phono: 50mV  
High Level: 5V Unbalanced  
10V Balanced

#### Voltage Gain

Phono to Tape/VCR Out: 40dB  
Phono to Output (Main): 54dB  
High Level to Tape/VCR Out: 0dB  
High Level to Output (Main): 14dB

#### Tone Controls

Bass Control: ±12dB at 30Hz  
Treble Control: ±12dB at 10,000Hz

### General Specifications

#### Power Requirements

100 Volts, 50/60Hz at 65 watts  
110 Volts, 50/60Hz at 65 watts  
120 Volts, 50/60Hz at 65 watts  
220 Volts, 50/60Hz at 65 watts  
230 Volts, 50/60Hz at 65 watts  
240 Volts, 50/60Hz at 65 watts

*Note: Refer to the rear panel of the MX136 for the correct voltage.*

#### Overall Dimensions

Width is 17-3/4 inches (45.09cm)  
Height is 9-7/16 inches (23.97cm) including feet  
Depth is 18-3/4 inches (47.63cm) including the Front Panel and Knobs

#### Weight

31 pounds (14.06Kg) net, 55 pounds (24.95Kg) shipping

#### Shipping Carton Dimensions

Width is 25 inches (63.5cm)  
Depth is 28 inches (71.12cm)  
Height is 18-3/8 inches (46.67cm)

<sup>1</sup> If any of the Channels have the Loudspeaker Setting of Small, the subwoofer has an electronic low pass filter with a 24dB per Octave rolloff in all modes except external.

## TM1 AM/FM Tuner Module

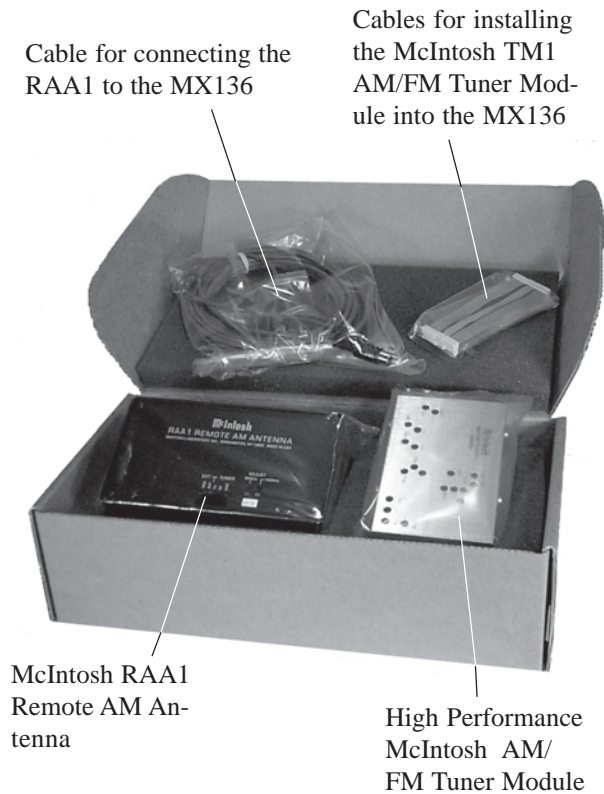

### Introduction

The MX136 A/V Control Center has provisions for adding an optional McIntosh TM1 AM/FM Tuner Module for Radio Station Reception. The TM1 delivers the same exceptional performance as the stand-alone McIntosh MR85 Tuner. The TM1 is available from your McIntosh Dealer and can be installed at any time, usually while you wait.

### Performance Features

- **Special FM RF Amplifier**

Double-Diffused Metal Oxide Field Effect Transistor (DMOS-FET) RF amplifier increases sensitivity and Cross Modulation rejection.

- **External AM RF Amplifier and Antenna**

The TM1 includes a RAA1 Remote AM Antenna that contains an electrostatically shielded AM RF Amplifier Stage for maximum noise rejection. It can be located in a remote area, away from sources of interference and can be positioned for the best possible reception of even the weakest AM stations.

- **FM Stereo Auto Blend Circuitry**

An automatic variable stereo separation control circuit is used to reduce background noise when receiving weak stereo stations.

- **Preset Stations and Permanent Memory**

Nine AM and nine FM station presets make it easy to listen to your favorite stations. Station Presets and Functions Modes are retained in Permanent Memory even when AC power is switched Off.

- **Alphanumeric Fluorescent Display**

The MX136 Multi-function Front Panel Display indicates station frequency, station preset number, signal strength, stereo and broadcast band.

### TM1 Table of Contents

Introduction .....	52
Performance Features .....	52
MX136 Rear and RAA1 Top Panels	
Antenna Connections .....	53
How to Connect Antenna Components .....	54
How to Operate the Tuner .....	55
How to Assign Preset Stations .....	56
How to Optimize AM Reception .....	57
FM Specifications .....	58
AM Specifications .....	58

# MX136 Rear Panel and RAA1 Top Panel Antenna Connections

RAA1 Remote Antenna can be adjusted to a position for optimum reception of your favorite AM stations

Connects with supplied cable to the MX136



AM ANT (Antenna) connector allows a McIntosh Remote Antenna to be connected



*Note: Proceed to page 13 and start the connection process.*

75 OHM FM ANT (Antenna) connects to an external FM Antenna or cable



## How to Connect Antenna Components

1. Connect the Remote AM Antenna by plugging the DIN Connector of the supplied 3 conductor cable into the AM ANTenna, DIN socket on the back panel of the MX136.

*Note: If a longer length cable needs to be used between the MX136 and the RAA1, use a 2 conductor shielded cable.*

2. Connect a 75 ohm coax cable from an FM Antenna or cable system to the MX136, 75 OHM FM ANTenna Connector.
3. Proceed to page 19 and continue the connection process.

### RAA1 Connector

Connect the shield and two leads of a shielded 2 conductor cable to the supplied 5 Pin Terminal Connector Plug. Refer to the connection information on the top cover of the RAA1.

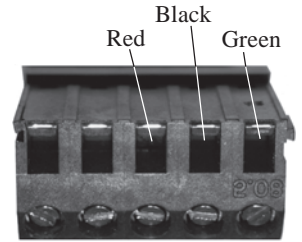

### 7 Pin DIN Connector

- |               |  |
|---------------|--|
| 1. Red Wire   | 5. N/C                                     |
| 2. Black Wire | 6. Jumper from Pin 7                       |
| 3. N/C        | 7. Green Wire (Shield) and Jumper to Pin 6 |
| 4. N/C        |  |

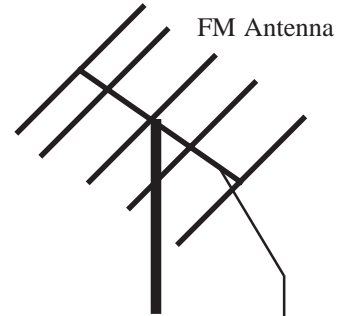
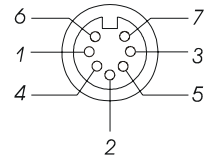

## How to Tune Stations Manually

The McIntosh MX136 TM1 AM/FM Tuner Module incorporates an advanced design AM/FM Tuner with many desirable performance features to enhance your enjoyment of radio broadcasts. There are four methods of tuning to an AM/FM Broadcast Station. These are Manual, Automatic Preset Review, Preset Push-button Search and Direct Preset Number Access using the Remote Control.

1. Select TUNER with the Front Panel INPUT A (Listen) Switch or the Remote Control. Refer to figure 62.
2. Press the SELECT Push-button on the Front Panel until the desired AM or FM Broadcast Band is selected.
3. Press the Front Panel TUNING Up▲ or Down▼ Push-button to select stations. Press and release the TUNING Push-buttons to move from one station to the next. Press and hold to move continuously up or down the broadcast band.

When a station is selected, the Front Panel Alphanumeric Display will indicate (from left to right) Station Signal Strength from 1 to 9, a dot if the Broadcast is Stereo, the AM or FM Station Frequency, AM or FM Broadcast Band and a Preset Number (if that station has been assigned a Preset). Refer to figures 63 and 64.

*Notes: FM Broadcast Band Indications are in Megahertz in the US and Canada, and change frequency in 200kHz steps. The second digit to the right of the dot which displays a 0, is used for FM stations in various locations other than the US where stations change in 50kHz steps. AM Broadcast Band Indications are in Kiloherertz and change frequency in 10kHz steps.*



Figure 63

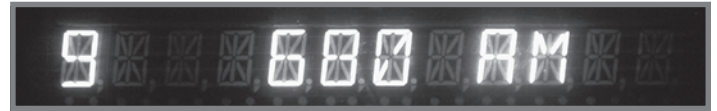

Figure 64



Figure 62

### How to Assign Preset Stations

The MX136 AM/FM Tuner Module (TM1) allows for pre-setting radio stations into memory. To enter Presets follow the below steps:

*Note: If there are no Presets Assigned and either the Front Panel PRESET Push-buttons or the Remote Control +10 Push-button are pressed, the MX136 Front Panel Alphanumeric Display will indicate NO PRESETS. Refer to figure 65.*



Figure 65

1. Select either the AM or FM Broadcast Band.
2. Press the Front Panel TUNING Up▲ or Down▼ Push-button to select a station.
3. Momentarily press and release the Front Panel ENTER Push-button. The Front Panel Alphanumeric Display will indicate 1 AVAILABLE, which is the first of 9 Preset Numbers that can be assigned. The Station that is about to be entered into memory may also be assigned to a different Preset Number (2-9) by pressing the PRESET Left◀ and Right▶ Push-buttons to select the desired Preset Number. Refer to figure 66.

*Note: Presets are automatically assigned in order from 1 to 9 unless a different Preset Number is selected.*



Figure 66

4. Press and release the Front Panel ENTER Push-button a second time to store the Preset into memory. The just entered Station Preset Selection will be assigned Preset Number 1 which is displayed on the far right side of the Front Panel Alphanumeric. Refer to figure 67.



Figure 67

5. Assign additional station Presets by performing steps 1 through 5 until a total of 9 AM and 9 FM Station Presets have been assigned. Each time you assign an additional Preset Number, the Front Panel Alphanumeric Display will indicate the number of the next available Preset.

*Note: If all 9 Presets are assigned and the ENTER Push-button is pressed, the display will indicate the station selected for Preset Number 1.*

6. To verify the Station Preset(s) just entered into memory, press the PRESET Left◀ and Right▶ Push-buttons to cycle through and confirm your preset assignments.

### How To Clear an Assigned Station Preset

1. Press ENTER Push-button.
2. Press the Front Panel PRESET Left◀ and Right▶ Push-buttons to select the Preset Station that will be removed from memory.
3. Press and Hold the ENTER Push-button for approximately 3 seconds until the Front Panel Alphanumeric Display indicates the word CLEARED. Refer to figure 68.

*Note: If you wish to replace an already assigned Station Preset with another radio station, it is not necessary to clear the Preset first, just enter in the new station for that Preset. The new station will automatically replace the previously assigned station.*

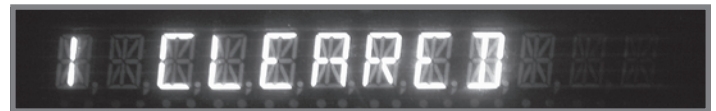

Figure 68

4. To clear any additional Station Presets perform steps 1 through 3 again.



## How to Optimize AM Reception

The McIntosh RAA1 Remote AM Antenna is designed to provide the best in AM Reception especially if the tuner or A/V unit is located in a noisy reception area. Locate the RAA1 away from all electronic and electrical interference sources. Rotate the AM Antenna to reduce interference and receive maximum signal strength.

*Notes: The RAA1 Remote AM Antenna of the TMI has been factory adjusted for optimum reception in a typical urban location. If you wish to customize the AM Antenna for the best possible performance in your location, have your dealer perform the two adjustment operations listed below. An additional long wire AM antenna or external ground can be connected to the GND and ANT terminals if desired.*

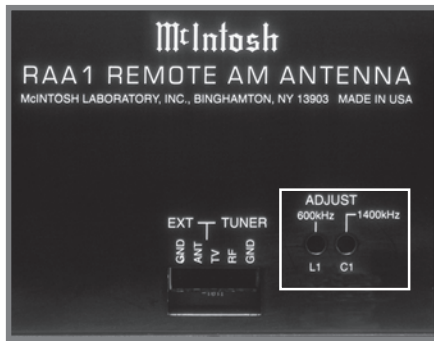

Figure 69

1. Tune to a weak AM station near 600kHz on the AM band. Using an appropriate **NON - METALLIC** tool, adjust the 600kHz Trans-

former L1 for maximum signal strength. Refer to figure 69.

2. Tune to a weak AM station near 1400kHz on the AM band. Using an appropriate **NON - METALLIC** tool, adjust the 1400kHz Trimmer Capacitor C1 for maximum signal strength.
3. Repeat steps 1 and 2 until no further improvements can be obtained.

FM and AM Station Presets				
Preset Number	Frequency	City	Call Letters	Name
FM 1				
FM 2				
FM 3				
FM 4				
FM 5				
FM 6				
FM 7				
FM 8				
FM 9				
AM 1				
AM 2				
AM 3				
AM 4				
AM 5				
AM 6				
AM 7				
AM 8				
AM 9				



---

## FM Tuner Specifications

### Useable Sensitivity

14dBf which is 1.4uV across 75 ohms

### 50dB Quieting Sensitivity

Mono: 19dBf which is 2.4uV across 75 ohms

Stereo: 35dBf which is 15uV across 75 ohms

### Signal To Noise Ratio

Mono: 75dB

Stereo: 70dB

### Frequency Response

Mono: + 0, - 1dB from 20 to 15,000Hz

Stereo: + 0, - 1dB from 20 to 15,000Hz

### Harmonic Distortion

Mono: 0.3% at 100Hz

0.3% at 1,000Hz

0.3% at 10,000Hz

Stereo: 0.45% at 100Hz

0.45% at 1,000Hz

0.65% at 10,000Hz

### Intermodulation Distortion

Mono 0.25%

Stereo 0.45%

### Capture Ratio

1.2dB

### Alternate Channel Selectivity

75dB

### Spurious Response

100dB

### Image Response

75dB

### RF Intermodulation

65dB

### Stereo Separation

45dB at 100Hz

45dB at 1,000Hz

35dB at 10,000Hz

### SCA Rejection

65dB

---

## AM Tuner Specifications

### Sensitivity

20uV External Antenna Input

### Signal To Noise Ratio

48dB at 30% modulation

58dB at 100% modulation

### Harmonic Distortion

0.5% maximum at 50% modulation

### Frequency Response

50Hz to 6kHz NRSC

### Adjacent Channel Selectivity

45dB minimum IHF

### Image Rejection

65dB minimum from 540 to 1600kHz

### IF Rejection

80dB minimum

**Packing Instructions**

In the event it is necessary to repack the equipment for shipment, the equipment must be packed exactly as shown below. It is very important that the four plastic feet are attached to the bottom of the equipment. This will ensure the proper equipment location on the bottom pad. Failure to do this will result in shipping damage.

Use the original shipping carton and interior parts only if they are all in good serviceable condition. If a shipping carton or any of the interior part(s) are needed, please call or write Customer Service Department of McIntosh Laboratory. Please see the Part List for the correct part numbers.

Quantity	Part Number	Description
1	034256	Shipping carton only
2	034270	Foam end cap
1	034198	Inside carton top only
1	034199	Inside carton bottom only
1	033725	Top pad
1	034301	Bottom pad
4	017937	Plastic foot
4	400159	#10-32 x 3/4" screw
4	404080	#10-7/16" Flat washer

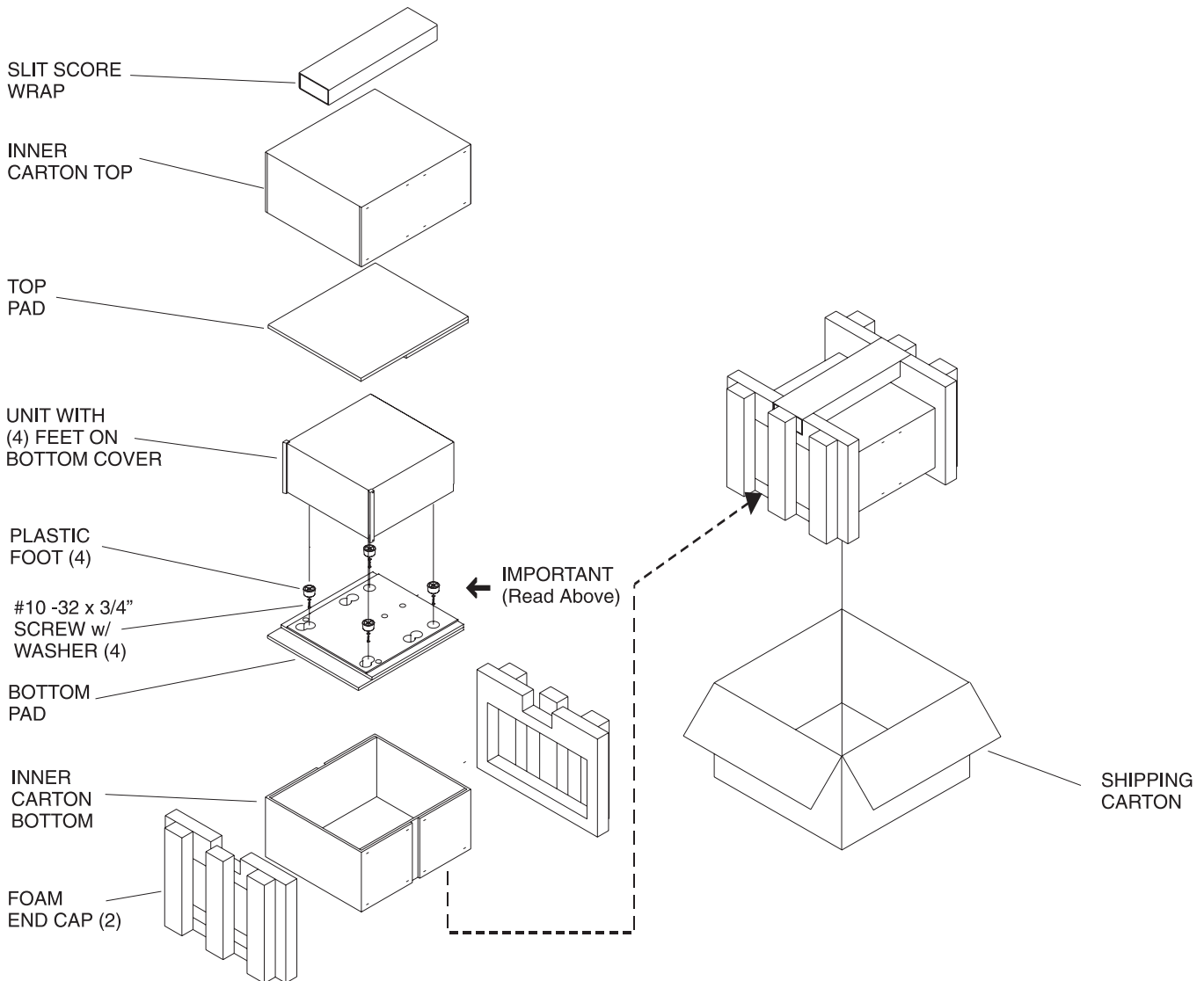



McIntosh Laboratory, Inc.  
2 Chambers Street  
Binghamton, NY 13903

The continuous improvement of its products is the  
policy of McIntosh Laboratory Incorporated who  
reserve the right to improve design without notice.  
Printed in the U.S.A.